

Haier

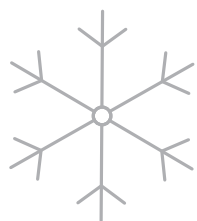

MRV sistemi
Kommercijsalna serija
Kućna serija



KATALOG **KLIMA UREĐAJA** **2025/2026.**

Haier KLIMA UREĐAJI

Profesionalna klimatizacija
s rješenjima za zdrav zrak u domu.

Haier VIZIJA

Biti prepoznat kao lider u globalnoj HVAC industriji po tehnološkim inovacijama, kvalitetnim proizvodima i uspješnom poslovnom modelu.

Haier MISIJA

Razvijati inovativnu tehnologiju u segmentu pametnog upravljanja i unaprjeđivati funkcije za poboljšanje kvalitete zraka.



SADRŽAJ

Haier GRUPA	/02
Haier globalna pozicija	/04
Haier Centar za istraživanje	/05
Haier pregled značajnih događaja	/06
Haier RJEŠENJA ZA KLIMATIZACIJU DOMA	/08
Ultimativno zdravlje	/10
Ultimativne pametne funkcije	/18
Ultimativni komfor	/22
Ultimativna fleksibilnost	/29
LINIJA MODELA KLIMA	/32
Pregled funkcija	/32
Prednosti	/38
Pregled modela	/42
KUĆNA SERIJA KLIMA UREĐAJA	/44
Expert Nordic	/44
Expert	/46
Flexis Plus	/48
Pearl Premium	/50
Pearl	/52
Tundra Plus	/54
Tide Plus	/56
Mobilni klima uređaj	/58
R32 SUPER MATCH MULTI SUSTAVI	/60
Pregled modela	/62
Multi inverter	/66
KOMERCIJALNA SERIJA KLIMA UREĐAJA	/68
Kompaktni kazetni model	/70
360° kazetni model	/72
Slim kanalni model	/74
Kanalni model srednji ESP	/76
Kanalni model visoki ESP	/78
Podnastropni model	/80
Podni inverter model	/82
Haier MRV SISTEMI	/84
MRV sustavi	/87
TEHNIČKI PODACI	/92
Upravljanje	/92
Dimenzije unutarnjih jedinica	/93
Dimenzije vanjskih jedinica	/95

Haier GLOBALNA POZICIJA



SVJETSKI BROJ 1

Haier je 16 godina za redom proglašen najvećim svjetskim brandom bijele tehnike u svijetu po količini prodaje. Istraživanje je napravljeno od strane neovisne agencije za istraživanje svjetskog tržišta Euromonitor International.



SVJETSKI BROJ 1 U KATEGORIJI "PAMETNIH" KLIMA UREĐAJA

Sedmu uzastopnu godinu Haier je svjetski broj 1 u kategoriji pametnih klima uređaja.



FORTUNE: HAIER MEĐU NAJCJENJENIJIM KOMPANIJAMA

Brand Haier proglašen je jedan od najcjenjenijih brandova u svijetu za 2024. godinu na temelju razvojne strategije u čijem središtu je krajnji korisnik.



BRANDZ TOP 100 NAJVRJEDNIJIH BRANDOVA

Jedini brand koji je četiri uzastopne godine na svjetskoj listi BrandZ TOP 100 najcjenjenijih svjetskih brandova u kategoriji IoT (Internet of Things) ekosustava.



FORTUNE GLOBAL 500

U 2024. Fortune GLOBAL 500 uvrstio je još jednom kompaniju Haier Smart Home Co među TOP 500 kompanija.

Haier CENTAR ZA ISTRAŽIVANJE I RAZVOJ



Haier & Mitsubishi
Joint Laboratory

Haier & Highly
Joint Laboratory

Laboratorij za istraživanje i razvoj



Comfort Test



Rainfall Test



Performance Test



Safety Test



Noise Test



EMC Test



Snow Test



Sunshine Test



Reliability Test



Humidity Test



Double 85 Test



Drop Test

Popis certifikata



Haier PREGLED ZNAČAJNIH DOGAĐAJA



Osnovan u
Qingdau, Kina.

1984



Lansiran prvi
inverter klima uređaj.

1993



Stečen certifikat
ISO9001.

1994



Lansirana
komercijalna
serija klima uređaja.

1996



Započinje izvoz
klima uređaja u SAD.

1999



MB Frigo Grupa postaje
generalni distributer Haier
klimatizacijskih sustava
na području Adria regije.

2001



Osmišljena IoT tehnologija.

2015



Akvizicija kompanije GE.

2016



Akvizicija kompanije Candy.

2018



Osmišljena UVC tehnologija.

2021



Haier lansirao UVC PRO tehnologiju.

2022



7. godinu zaredom Svjetski br. 1 u kategoriji "pametnih" klima uređaja.

2023



Akvizicija Carrier Commercial Refrigeration.

2024

Haier

Haier RJEŠENJA ZA KLIMATIZACIJU DOMA

Odaberite komfor i čist zrak u domu

KUĆNA SERIJA
KLIMA UREĐAJA





ULTIMATIVNE FUNKCIJE ZA ZDRAVLJE



ULTIMATIVNE PAMETNE FUNKCIJE



ULTIMATIVNE FUNKCIJE ZA KOMFOR



ULTIMATIVNE FUNKCIJE ZA MONTAŽU



Ultimativno zdravlje

ODRŽAVANJE KLIMA UREĐAJA ČISTIM**FROST CLEAN**

Automatsko samočišćenje hladnom ekspanzijom - zaleđivanjem površine isparivača učinkovito se uklanjaju nečistoće i bakterije.

**56°C STERILIZACIJA**

Ubija bakterije i viruse zagrijavanjem isparivača na visokih 56°C tijekom 30 minuta.

**SELF HYGIENE**

Komponente kroz koje prolazi zrak zaštićene su premazom koji sadrži srebrne nanočestice. Eliminacija plijesni i bakterija iz zraka do 99,9%.

**EASY TO CLEAN**

Inovacija za čist zrak koja omogućuje jednostavno vađenje ventilatora i filtera za dubinsko čišćenje klima uređaja.



Ultimativno zdravlje

ISPORUKA ZDRAVOG ZRAKA

UVC STERILIZACIJA

Ugrađeno UV LED svjetlo sterilizira zrak koji cirkulira klima uređajem. Učinkovito eliminira viruse i bakterije pri čemu isporučuje zdrav zrak u prostoriju.

Texcell

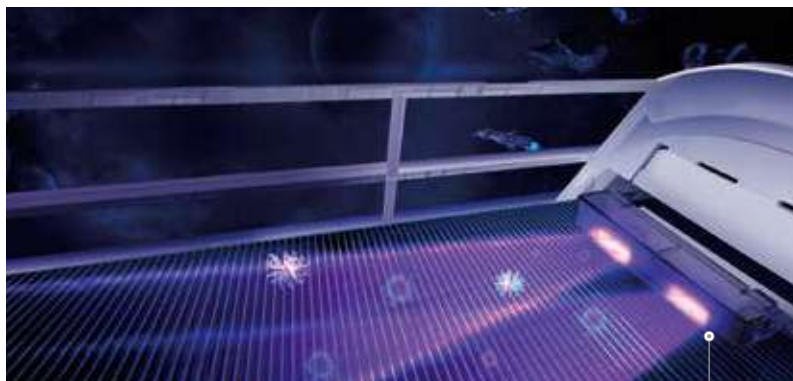

UVC PRO MODUL + IONIZATOR

UVC Pro istovremeno sterilizira unutarnju jedinicu i zrak u prostoriji. Uz pomoć UVC zraka i plazme, osigurana je vrhunska kvaliteta zraka i čistoća uređaja.

ULTIMATIVNO ZDRAVLJE

Uvijek čist i svjež zrak



Znate li da kroz klima uređaj prolazi sav zrak iz zatvorene prostorije i to više puta dnevno? U zatvorenim prostorima provodimo najviše vremena te kvaliteta zraka koji udišemo izravno utječe na naše zdravlje. Zagađeni zrak izvana ulazi u uredske prostorije ili naš dom kroz prozore i vrata, ali i kroz ventilaciju. S zrakom u prostor dolaze i štetne čestice od ispušnih plinova, čađe, prašine, peludi, itd.

U većim gradovima, pogotovo u područjima s frekventnijim prometom, zrak je još zagađeniji.

Haier već godinama razvija dodatne funkcije za pročišćavanje zraka u klima uređajima kako bi korisnicima omogućio svjež i pročišćen zrak u njihovim domovima.

Početak 2020. brand Haier dobio je svjetsku potvrdu od neovisne agencije za istraživanje svjetskog tržišta Euromonitor International za najučinkovitije antialergijsko djelovanje klima uređaja "Allergy-Free Tick-Mark Certificate" i postao najprodavaniji brand klima uređaja u kategoriji sterilizacije zraka.

Čistoća klima uređaja



Frost Clean



56°C Sterilizacija



Self-hygiene



Easy to clean

Pročišćavanje zraka



UVC Sterilizacija



UVC PRO
Sterilizacija

FROST CLEAN

Automatsko samočišćenje hladnom ekspanzijom – zaleđivanjem površine isparivača učinkovito se uklanjaju nečistoće i bakterije.



TEHNOLOGIJA

Koristi vlagu iz zraka kako bi smrznula površinu isparivača, te na taj način vezala čestice nečistoće, da bi ih zatim brzim zagrijavanjem otopila i kroz odvod uklonila. Uz to, dodatnim zagrijavanjem isparivača, dodatno se uništavaju bakterije kako bi izlazni zrak bio 99% čist.

Hladna ekspanzija



Zaleđivanjem površine isparivača učinkovito se uklanjaju nečistoće i bakterije.

Express tehnologija pranja



Hidrofilni aluminij s manjim kutom pomaže povećati učinkovitost odvodnje vode za 20%.

Antibakterijska tehnologija



Ionski srebrni premaz na isparivaču uz pomoć kojeg se dobiva 99,9% dezinficirani zrak. Ionsko srebro djeluje kao antiseptik zbog njegovih iona koji mogu prodrijeti kroz membranu bakterija.

PREDNOSTI



Isporka čistog zraka

Inovativna tehnologija ubija bakterije i dezinficira isparivač.



Ušteda troškova čišćenja

Čišćenje klima uređaja jednostavnim klikom na upravljač bez dodatnih troškova.

TUV CERTIFIKAT



56°C STERILIZACIJA

Ubija bakterije i viruse zagrijavanjem isparivača na visokih 56°C tijekom 30 minuta.

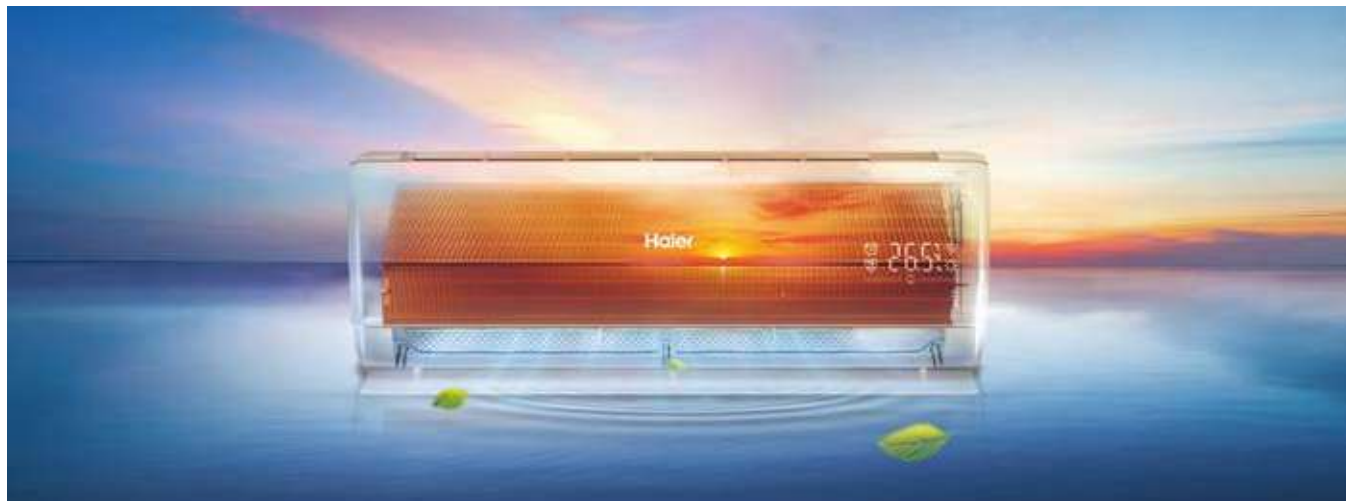

TEHNOLOGIJA



30+ minuta

Sterilizacija na visokoj temperaturi

Pametna kontrola frekvencije kompresora

Inteligentno podešava frekvenciju kompresora za kontrolu temperature zavojnice, a zatim održava isparivač na visokih 56°C.

Učinkovita sterilizacija na visokoj temperaturi

Prema istraživanju, bakterije i virusi ne mogu preživjeti na temperaturi od 56°C (30 minuta). Nakon završetka postupka zagrijavanja, isparivač se trenutno hladi kako bi se postigla bolja izvedba sterilizacije.



SGS CERTIFIKAT



PREDNOSTI

Ispuh zdravog zraka

56°C sterilizacija visokom temperaturom suši komponente iznutra i ubija bakterije i viruse te tako osigurava ispuh zdravog zraka.

Jednostavno korištenje

Funkcija 56°C sterilizacija je dostupna putem mobilne aplikacije hOn, a može se uključiti jednim klikom.

ANTIBAKTERIJSKA TEHNOLOGIJA

Self-Hygiene

Ionski srebrni premaz na isparivaču uz pomoć kojeg se dobiva 99,9% dezinficirani zrak. Ionsko srebro djeluje kao antiseptik zbog iona koji mogu prodrijeti kroz membranu bakterija.



TEHNOLOGIJA

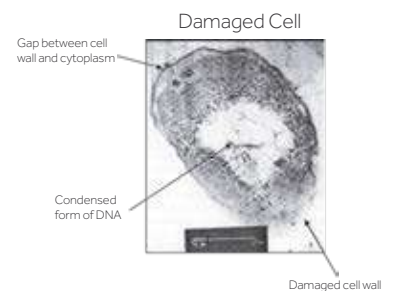
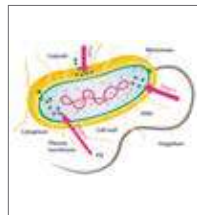
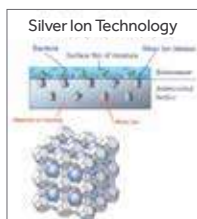

Nanočestice srebra

Plijesan i bakterije dio su zraka u zatvorenoj prostoriji. Njihova prisutnost narušava kvalitetu zraka, a mogu uzrokovati i bolesti. Strujanjem zraka kroz ventilator dio se nečistoća iz zraka može zalijepiti za elemente klima uređaja što pogoduje razvoju plijesni i bakterija.

Haier koristi nano čestice srebra koje kontinuirano otpuštaju nisku razinu iona srebra kako bi osigurao zaštitu od plijesni i bakterija.

PREDNOSTI



Ispuh zdravog zraka

Nano čestice srebra onemogućuju razvoj plijesni i bakterija unutar klima uređaja te osiguravaju ispuh čistog zraka u prostoriju.



Održavanje klima uređaja

Nanočestica srebra uništavaju 99,9% plijesni te onemogućuju razvoj bakterija. Idealno rješenje za pročišćavanje ustajalog zraka u prostoriji.

SGS CERTIFIKAT



UVC STERILIZACIJA

Ugrađeno UV LED svjetlo sterilizira zrak koji cirkulira klima uređajem. Učinkovito eliminira viruse i bakterije pri čemu isporučuje zdrav zrak u prostoriju.

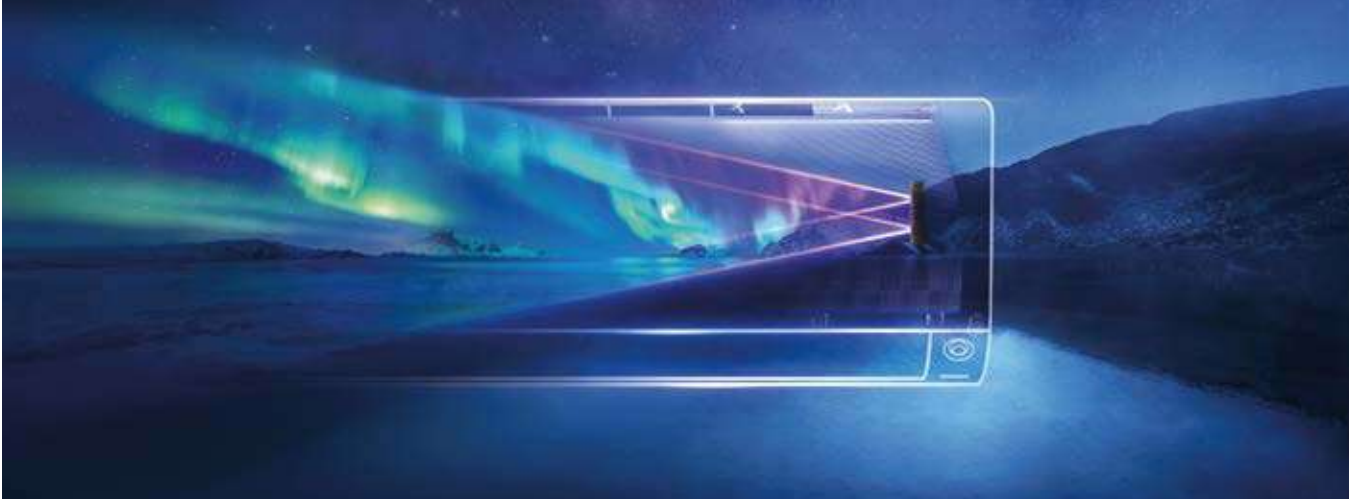

TEHNOLOGIJA

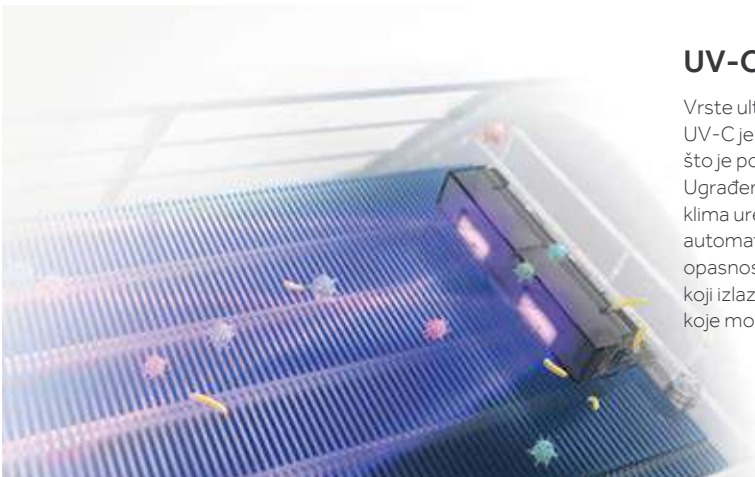

UV-C modul omogućuje do 99.9% čist zrak

Vrste ultraljubičastog zračenja: UVA, UVB i UV-C.

UV-C je energičnija valna duljina spektra u rasponu od 200-280 nm, što je posebno učinkovito u uništavanju genetske materije.

Ugrađeno LED UV svjetlo emitira zrake u blizini ulaza zraka u klima uređaj s desne na lijevu stranu. Zrak koji uđe u klima uređaj automatski je izravno izložen UV-C zrakama koje ubijaju sve opasnosti koje se nalaze u zraku poput virusa, bakterija i sl. Zrak koji izlazi iz klima uređaja 99,9% je pročišćen od svih opasnosti koje mogu ugroziti zdravlje.

PREDNOSTI



Sigurnost

LED UV uništava bakterije, viruse i sl. bez štetnih kemikalija i bez štetnog utjecaja na okoliš.

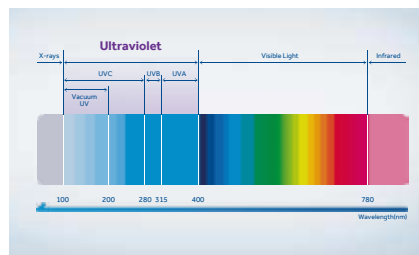

Učinkovita sterilizacija

Haier UVC sterilizacija koristi valnu duljinu između 265-275 nm, što je snažnije u uništavanju nevidljivih čestica u zraku koje su opasne za zdravlje

TEXCELL CERTIFIKAT



UVC PRO STERILIZACIJA

Inhibira razmnožavanje bakterija i sterilizira virus, razgrađuje molekulu vodika i kisika i stvara ionsku skupinu koja uništava bakterije i sterilizira viruse nakon kontakta.



TEHNOLOGIJA

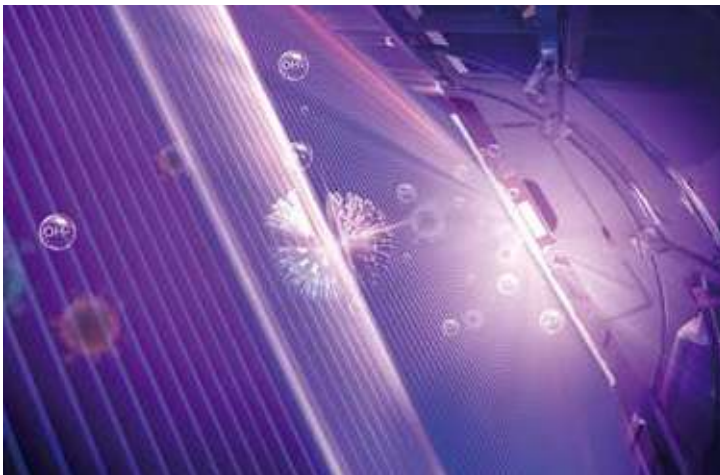

UVC Pro modul + ionizator

UVC Pro emitira UVC-zrake na ulazu zraka u klima uređaj. Direktno izlaganje UVC-C zrakama uništava strukturu DNA i RNA bakterija i virusa u zraku uzrokujući nemogućnost mikroorganizama da obavljaju vitalne stanične funkcije. Nova UVC Pro lampa stvara plazmu koja dodatno pospješuje sterilizaciju za zdraviji i čišći zrak u prostoriji.

PREDNOSTI



Ultimativna sterilizacija

UVC Pro istovremeno sterilizira unutarnju jedinicu i zrak u prostoriji. Uz pomoć UVC zraka i plazme, osigurana je vrhunska kvaliteta zraka i čistoća uređaja.

99.991%

Neovisnim testom dokazano je da novi UVC Pro modul inhibira SARS CoV 2 s 99,991% učinkovitosti.

TEXCELL CERTIFIKAT



ULTIMATIVNE PAMETNE FUNKCIJE

Budite povezani



Posljednjih godina bilježi se brzi razvoj telekomunikacija i IoT tehnologije. Malo je toga što ne možete učiniti jednim dodiranjem prsta na pametnim telefonima. Pametni uređaji postaju novi trend kućanstva u kojem je Haier preuzeo vodstvo. S pametnim funkcijama možete prilagoditi usluge svojim potrebama, kontrolirati svoj klima uređaj s bilo kojeg mjesta i u bilo koje vrijeme i još mnogo toga.

Haier je već 6 godina zaredom vodeći svjetski brend u kategoriji „pametnih “ klima uređaja s mogućnošću povezivanja.



WiFi kontrola



Eco senzor



Glasovne kontrole

WI-FI KONTROLA

Lako dostupna kontrola vašeg klima uređaja s bilo kojeg mjesta i bilo kada. „hOn” mobilna aplikacija budućnosti omogućava povezivanje svih kućanskih uređaja u vrhunsko SMART iskustvo.



TEHNOLOGIJA

WI-FI modul

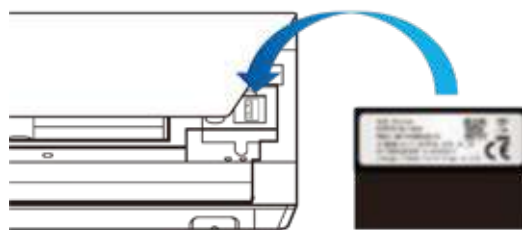
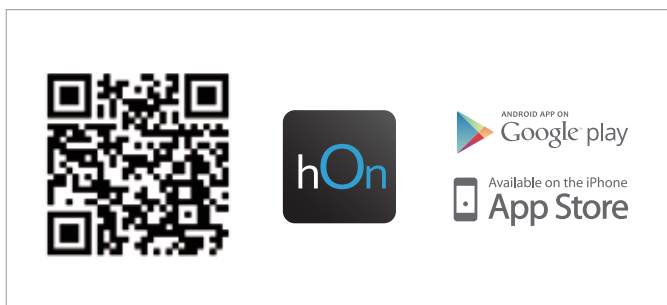

PREDNOSTI



Grupna kontrola

Upravljajte s više klima uređaja putem „hOn” aplikacije.



Pametni podsjetnici

Uključite pametne podsjetnike kako bi dobili obavijest o tome kada je vrijeme za čišćenje filtera klima uređaja..



Tjedni timer

Jednostavno namjestite tjedni raspored rada klima uređaja s jednim potezom na aplikaciji.



Upozorenje o pogrešci

Kôd pogreške prikazuje se ako klima uređaj ne radi ispravno.



Jednostavno upravljanje klima uređajem

Bez obzira gdje se nalazite, možete jednostavno upravljati s klima uređajem putem „hOn” aplikacije.



Prilagodite rad klima uređaja

Istražite opcije korištenja klima uređaja prema vašim zahtjevima.



Glasovne naredbe

Ugrađena glasovna kontrola omogućuje upravljanje s Haier klima uređajem putem glasovnih naredbi.



Godišnji odmor

S jednim klikom možete uključiti opciju Godišnji odmor.



Potrošnja el. energije

Putem „hOn” aplikacija pratite potrošnju Haier klima uređaja i uvjerite se u učinkovitost napredne tehnologije u segmentu uštede energije.

GLASOVNO UPRAVLJANJE

Iako imate kontrolu u Vašim rukama, nemate uvijek „treću“ ruku. Uživajte u pogodnostima pametnog upravljanja klima uređajem prilagođenog Vašim potrebama. Uz pomoć svog glasa uključite/isključite klima uređaj, promijenite način rada, podesite temperaturu ili provjerite trenutni status rada klima uređaja.



TEHNOLOGIJA



Vanjski glasovni modul

Modul u obliku utičnice povezuje vas s klima uređajem putem vašeg glasa. Kada ne možete pronaći daljinski upravljač, dovoljno je da samo govorite i bezbrižno upravljate svojim klima uređajem.



Integracija zvučnika treće strane

Putem zvučnika ili pametnog telefona, Google Assistant i Amazon Alexa omogućuju vam interakciju s klima uređajem. Glasovna kontrola funkcija temperature, načina rada itd.

PREDNOSTI



Intuitivno upravljanje uređajem hands-free

Nekoliko načina kako biste govorom s Alexom upravljali Haier pametnim klima uređajima:

Uključi/isključi klima uređaj.

Postavi klima uređaj na hlađenje/grijanje ili pametni način rada.

Koji način rada je postavljen na klima uređaju?

Da li je klima uređaj uključen/isključen?

Koja je temperatura postavljena na klima uređaju?

Postavi temperaturu klima uređaja na 20 °C.

ECO SENZOR

Senzor automatski detektira aktivnost osobe u sobi, a zatim prebacuje uređaj u način rada koji najbolje odgovara željenom ambijentu. Poboljšava energetska učinkovitost i korisničko iskustvo.



TEHNOLOGIJA

S dva integrirana modula, eko senzor istovremeno detektira dva područja s kutom do 120° i udaljenosti čak 8 metara. Senzor automatski analizira aktivnost osoba u prostoriji i zatim prilagođava protok zraka koji slijedi ili izbjegava korisnika ovisno o njegovim individualnim potrebama.

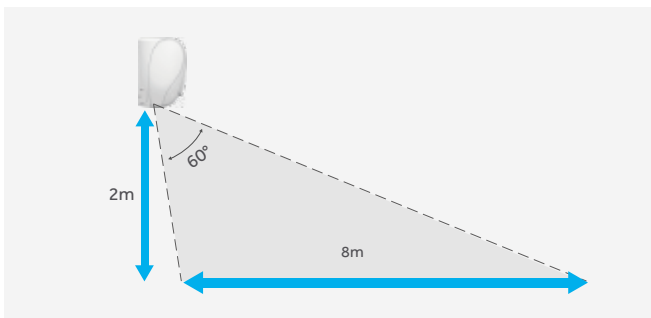

Vertikalno područje detekcije

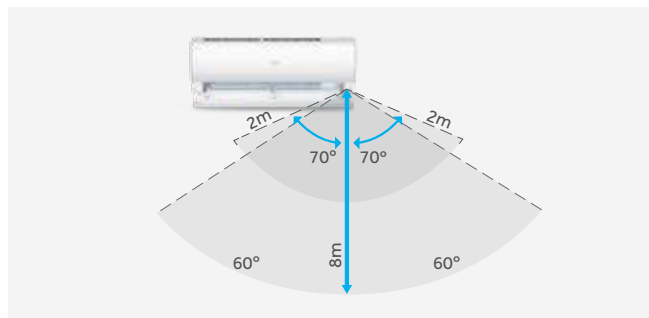

Horizontalno područje detekcije

PREDNOSTI

Ugodno iskustvo

Ukoliko je uključen **Follow** način rada, strujanje zraka pratit će kretanje korisnika u području A. Ukoliko je uključen **Avoid** način rada, strujanje zraka izbjegavat će korisnika u području B. Ukoliko senzor detektira korisnike u oba područja, klima uređaj će se automatski prebaciti u Swing način rada.

Ušteda energije

ECO senzor inteligentno prepoznaje položaj i kretanje ljudi u sobi. Kad je soba prazna, klima uređaj se za 20 minuta prebacuje u način uštede energije.

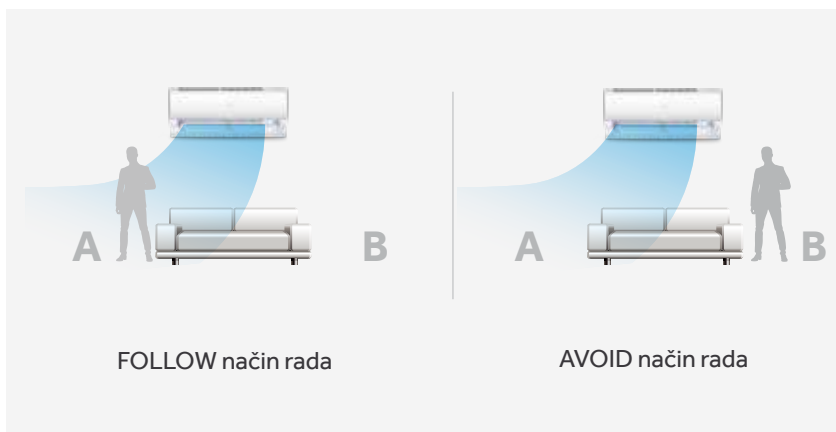

ULTIMATIVNI KOMFOR

Savršena udobnost u prostoru



Haier konstantno ulaže u razvoj inovativnih funkcija za komfor uz pomoć kojih zadovoljava i one najzahtjevnije korisnike.

PID inverter tehnologija omogućuje još brže postizanje željene temperature i preciznije održavanje temperature (tempomat za precizno održavanje željene temperature). Ispuh zraka unaprijeden je s trostrukim protokom i usmjerivačem koji generira jači i koncentriraniji ispuh zraka kako dospio u svaki kut prostorije. Haier klima uređaji već su dobro prepoznati po vrlo tihom radu 15 dB koji je tiši od šapata.



Hyper PCB



Inverter PLUS



Antikoroziivna
zaštita



Coanda Plus
protok zraka



I Feel



Super tihi rad

HYPER PCB

Pružila konstantno, snažno hlađenje i optimizirani dizajn kako bi savladala fluktuacije napona i neočekivana oštećenja koja mogu dovesti do kvara klima uređaja.



TEHNOLOGIJA

Višeslojni konformni premaz

PC pločica je prekrivena višeslojnim zaštitnim konformnim premazom koji štiti od vlage, kemikalija, insekata i ekstremnih temperatura.

Kompaktan dizajn

Zbog svojih manjih dimenzija zauzima manji prostor u odnosu na standardne PC pločice. Minimiziran je utjecaj na učinkovitost rada izmjenjivača topline te je omogućen veći prostor za ostale komponente.



Materijal FR-4

Svojstva materijala FR-4 su vatro otpornost, odlično zadržavanje visokih mehaničkih karakteristika i svojstvo električnog izolatora, kako u suhim tako i u vlažnim uvjetima.

Smart Power Module

Ugrađeni senzor temperature visoke razlučivosti, kontrolira radnu učinkovitost kompresora za postizanje vrhunskih performansi hlađenja i grijanja.

PREDNOSTI



Stabilnija PC pločica

PC pločica radi stabilno između 130V-264V, a može početi na minimumu od 130V. Omogućuje stabilno hlađenje klima uređaja u ekstremnim uvjetima.

Izdržljivija PC pločica

Poseban dizajn i kvalitetniji konformni premaz štite komponente PC pločice od raznih elemenata koji joj skraćuju vijek trajanja.

INVERTER PLUS

Haier je razvio Inverter plus tehnologiju koja osigurava pametnu kontrolu klima uređaja za maksimalnu udobnost, pouzdanost i učinkovit rad jedinice.



TEHNOLOGIJA

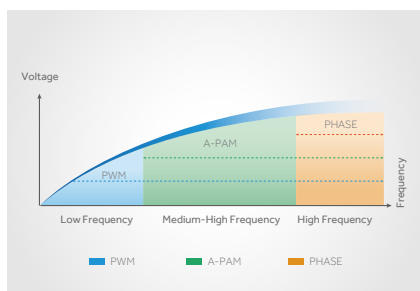

TLFM inverter tehnologija

Inverter koristi 3 različite kontrole napona za upravljanje optimalnom učinkovitosti u svakom frekventnom području.

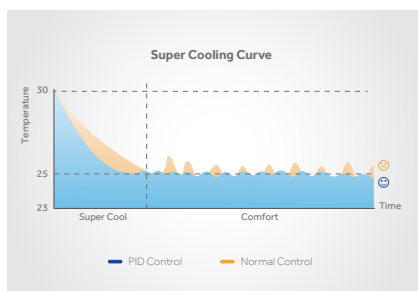

PID inverter tehnologija

Inverter maksimalno povećava radnu frekvenciju uređaja do postizanja željene temperature prostora, nakon toga stalno radi prilagodbe u stvarnom vremenu kako bi se ta temperatura i održavala.

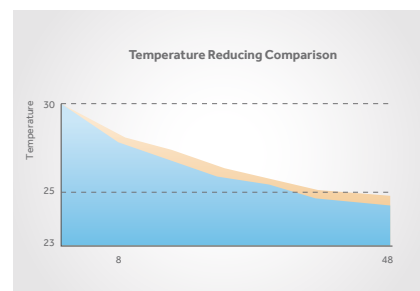

A-PAM inverter tehnologija

Inverterska tehnologija koja automatski podešava DC napon kompresora u skladu sa stvarnim opterećenjem istog kako bi se povećalo naponsko radno područje.

PREDNOSTI



Ušteda energije

Inverter plus tehnologija postiže visoku radnu učinkovitost u svim frekventnim područjima. Postiže se brži i jači efekt hlađenja i grijanja.

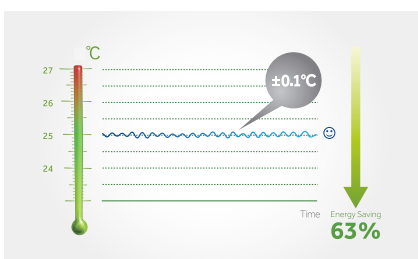

Vrhunska preciznost

Inverter Plus tehnologija puno brže postiže željenu temperaturu i zatim održava tu temperaturu s visokom preciznošću od $\pm 0,1^{\circ}\text{C}$



Pouzdan rad

Inverter Plus tehnologija prilagođava DC napon kompresora kako bi se postigao stabilan rad od 120V do 264V. Zbog toga korisnici Haier klima uređaja mogu nesmetano uživati u klimatiziranom prostoru bez obzira na varijacije napona na udaljenim područjima.

ANTIKOROZIVNA ZAŠTITA

Zaštitni antikorozivni premaz na isparivaču i vanjskoj jedinici klima uređaja sprječava nastanak korozije koja nastaje pod utjecajem kiše, vlage, slane vode i dr. Osigurava veću pouzdanost rada klima uređaja.



TEHNOLOGIJA



PREDNOSTI



SGS CERTIFIKAT

Izdržljiviji klima uređaj

Antikorozivni premaz povećava izdržljivost klima uređaja te na taj način omogućava dugoročnu uštedu za korisnika.

Još pouzdaniji klima uređaj

Antikorozivni premaz sprječava oštećenja bakrenih cijevi i curenje plina i na taj način osigurava najbolju izvedbu rada klima uređaja.

COANDA PROTOK ZRAKA

Osigurava dalji, brži i jači ispuh zraka iz klima uređaja te pruža osjećaj proljetnog povjetarca ravnomjerno raspoređenog u cijeloj prostoriji. Coanda efekt generira lagano strujanje zraka i usmjerava ispuh iz klima uređaja prema stropu. Na taj način zrak cirkulira prostorijom i stvara savršeno ugodan ambijent.



TEHNOLOGIJA

Coanda plus protok zraka nastaje uz pomoć 3 dodatka na lameli koji ispušni zrak precizno usmjeravaju kako bi zrak što prirodnije cirkulirao po prostoriji.



Promjena smjera ispuha zraka

Primjenom dvoslojne strukture klapne stvara se jedinstvena Arhimedova spirala koja usmjerava hladno strujanje zraka prema stropu pod kutem od 35°.



Ubrzanje ispuha zraka

Strujanje zraka prolazi kroz optimalni tlačni ekspanzijski kanal koji je uži unutra, a širi izvana između dvoslojne strukture klapne gdje se javlja Venturijev efekt tako da se protok zraka trenutno oslobađa/ispuhuje velikom brzinom.



Centraliziran ispuh zraka

Protok zraka ispod klapne, apsorbiran podtlakom stvorenim većom brzinom strujanja zraka iznad njega, pridružuje se glavnom protoku zraka i čini ga još jačim.

PREDNOSTI



Stropno hlađenje

Kada je uključen način rada hlađenje, hladni zrak se usmjerava prema stropu pod kutem od 35° kako bi se izbjeglo izravno puhanje u osobe u prostoriji. Ohlađeni zrak se ravnomjerno i brže raspoređuje u prostoriji od stropa prema podu čime se postiže veći komfor za korisnika.



Podno grijanje

Kad je uključen način rada grijanje, topli zrak se usmjerava prema podu koji potom cirkulira i osigurava uravnoteženu temperaturu u prostoru.

I FEEL

Detektira sobnu temperaturu uz pomoć daljinskog upravljača bez obzira gdje se nalazili u prostoriji. Klima uređaj optimizira rad kako bi korisniku omogućio najbolje klimatizacijske uvjete.



TEHNOLOGIJA

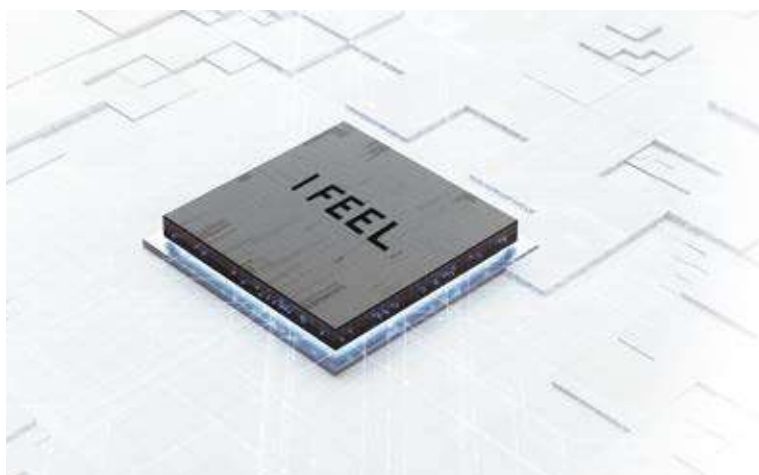

Izvedba klima uređaja može varirati u različitim uvjetima rada. Korisnik može osjećati nelagodu, ukoliko je sobna temperatura viša ili niža od očekivane.

Ugrađeni senzor temperature

Visoka rezolucija ugrađenog senzora, omogućava da daljinski upravljač može precizno pratiti temperaturu u prostoru.

Jednostavna kontrola

Klikom na tipku I Feel na daljinskom upravljaču, klima uređaj prima podatke o temperaturi prostora u realnom vremenu.

PREDNOSTI



Ugodno korisničko iskustvo

Funkcija optimizira radne uvjete klima uređaja kako bi isporučila klimatiziran zrak u potpunosti prilagođen potrebama korisnika.

ZVUK TIŠI OD ŠAPATA

Zamislite zvuk tiši od šapata. Klima uređaji Haier imaju novo rješenje kod funkcije tihog rada. Razina buke dovedena je do svega 15 dB. Za usporedbu, ljudski šapat mjeri se do 30 dB. Funkcije omogućavaju dodatno smanjenje razine buke klima uređaja. Ova funkcija pospešuje ugodu u prostoru, što je posebno potrebno kada se klima uređaj nalazi u spavaćoj sobi.



TEHNOLOGIJA



Optimizirani dizajn kućišta

Prostor gdje zrak ulazi je uvećan za 17%, prostor između isparivača i panela je dodatno proširen te je povećan otvor za izlaz zraka. Ova optimizacija pridonosi smanjenju razine buke kod rada klima uređaja.

Optimizirani ventilator unutarnje jedinice

Kut nagiba ventilatora optimiziran je na 25° kako bi se povećao protok zraka i minimalizirala buka rada ventilatora unutarnje jedinice.

Posebni sustav upravljanja

Posebni sustav upravljanja koristi A-PAM DC invertersku tehnologiju i DC motore, ovaj pristup pruža mogućnost visokog statičkog tlaka kako bi se minimalizirala buka u radu u unutarnje jedinice.

PREDNOSTI

Super tihi rad

Klima uređaj čiji rad je toliko tih da je nečujan i gotovo neprimjetan (15 dB).



75
dB(A)

10 metara
udaljenost od
autoputa



46
dB(A)

Vanjska jedinica
klima uređaja



20
dB(A)

Noć u prirodi



50
dB(A)

Normalna
govorna
konverzacija



30
dB(A)

Noć u pustinji



15
dB(A)

Šapatavi zrak

ULTIMATIVNA FLEKSIBILNOST

Fleksibilnost s lakoćom



Montaža bez puno napora, jednostavno i brzo održavanje i servisiranje bez demontaže isparivača, omogućuju veću učinkovitost na terenu u vrhuncu sezone.

Jednostavno održavanje i rastavljanje klima uređaja s lakim pristupom ventilatoru motora i kontrolnoj ploči.



Jednostavna
instalacija



Jednostavno
održavanje
i servisiranje



Super Match

FUNKCIONALNOST I UŠTEDA VREMENA

Jednostavna instalacija znači veću učinkovitost na terenu u vrijeme vrhunca sezone.

Jednostavna montaža, lako i brzo održavanje motora bez demontiranja isparivača.



TEHNOLOGIJA



Pozicioniranje na zid

Montažna ploča pomaže pri pozicioniranju klima uređaja na zid.



Nožica za lakši pristup

Jednostavni pristup i montiranje.



Dvosmjerni odvod kondenzata

Mogućnost priključenja odvoda kondenzata sa lijeve i desne strane za veću fleksibilnost kod montaže.



Širi prostor za cijevi

Ušteda vremena kod montaže.

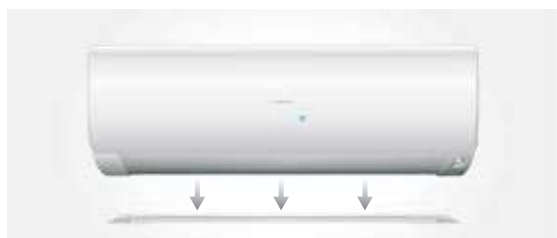

Odvojiv donji pokrov

Jednostavni pristup i montiranje.



Vanjski prekidač

Mogućnost uključanja/isključenja klima uređaja bez upotrebe daljinskog upravljača.

JEDNOSTAVNA MONTAŽA, ODRŽAVANJE I SERVISIRANJE

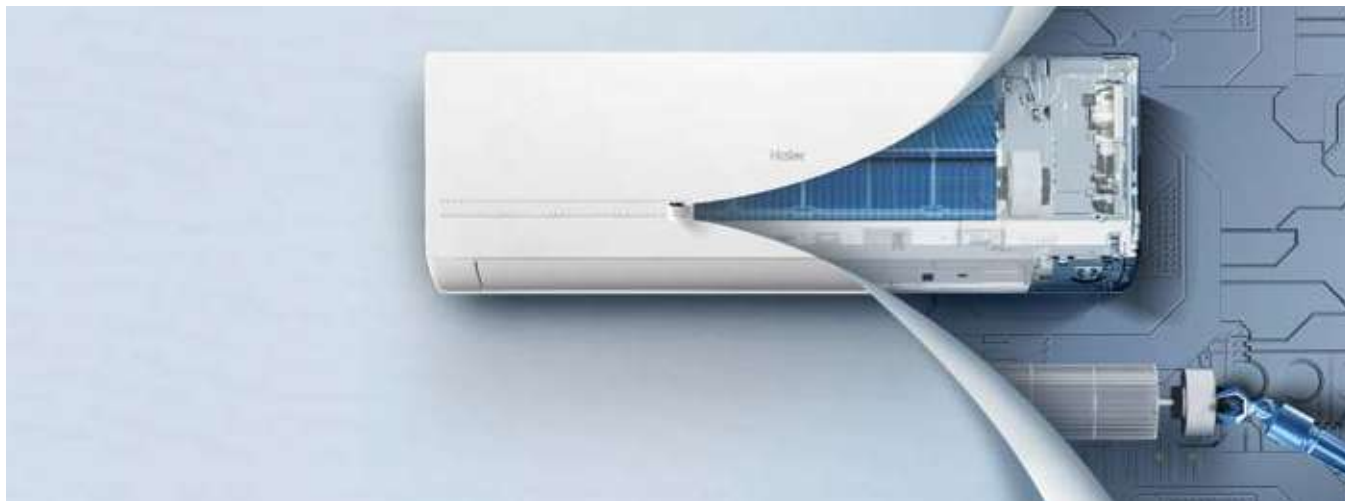

TEHNOLOGIJA



Rastavljanje PC pločice u 3 koraka

- Otvoriti prednji panel
- Otvoriti poklopac PC pločice
- Odspojiti terminale i izvaditi PC pločicu

Rastavljanje ventilatora i motora

- Otvoriti prednji panel
- Odvojiti donji poklopac
- Odspojiti terminale i izvaditi ventilator i motor

PREDNOSTI



80% brže
rastavljanje
PC pločice*



90% brže
rastavljanje
motora*



95% brže
rastavljanje
ventilatora*

SGS CERTIFIKAT



* Navedena tehnologija odnosi se na Expert model.

PREGLED FUNKCIJA

Ultimativno zdravlje



Frost Clean

Smrzava isparivač pomoću vlage iz zraka, te na taj način veže čestice nečistoće i otapanjem ih uklanja kroz odvod kondenzata, dok na ispuhu osigurava čist zrak.



56°C sterilizacija

Ubija bakterije i viruse zagrijavanjem isparivača na 56°C u trajanju od 30 minuta.



Self-higiene

Komponente kroz koje prolazi zrak zaštićene su premazom koji sadrži srebrne nanočestice. Eliminacija plijesni i bakterija iz zraka do 99,9%.



Easy to Clean

Nadogradnja Haier inovacija za zdrav zrak koja osigurava čist protok zraka iz klima uređaja. Jednostavno izvadite ventilator i filter za dubinsko čišćenje unutarnje jedinice.



UVC sterilizacija

Emitira UV zrake te na taj način sterilizira zrak koji prolazi kroz klima uređaj s učinkovitošću od 99,9%



UVC Pro

Sprečava razmnožavanje bakterija i sterilizira viruse. Razgradnjom kationa vodika i molekula kisika stvara ionsku skupinu koja inhibira bakterije i sterilizira virus nakon kontakta.



HAF Filter (3M Filter)

Koristi jaki elektrostatički naboj na površini filtera kako bi uklonio opasne mikro čestice, uključujući prašinu, viruse i bakterije te na taj način osigurao zdravije okruženje.



Blue Fin

Zbog hidrofилnog i anti korozivnog premaza, kondenzat otječe glatko i brzo. Učinkovitije uklanja mikro čestice poput prašine, virusa i bakterija te na taj način osigurava zdravije okruženje.

Ultimativne pametne funkcije



Glasovne kontrole

Uživajte u bežičnom glasovnom upravljanju svojim pametnim klima uređajem, kompatibilnim s digitalnim asistentima Amazon Alexa i Google Assistant.



WiFi kontrola

Preuzimanjem Haier hOn aplikacije na pametni uređaj (Apple ili Android), omogućuje se upravljanje i kontrola klima uređaja s bilo koje lokacije i bilo kada.



Eco senzor

Detektira stanje u prostoru, te ljudsku aktivnost u realnom vremenu, te prilagođava način rada kako bi postigao najbolju energetska učinkovitost i udobnost za korisnike.

Ultimativni komfor



Coanda Plus protok zraka

Osigurava dalji, brži i jači ispuh zraka iz klima uređaja, kako bi zrak bio jednakomjerno raspodijeljen po cijeloj prostoriji.



A-PAM Control

Automatski prilagođava napon uređaja ovisno o opterećenju kompresora, te na taj način postiže veću uštedu.



PID Control

Maksimizira radnu frekvenciju kako bi u što kraćem roku postigao željenu temperaturu prostora, a nakon toga u realnom vremenu stalno prilagođava frekvenciju uređaja kako bi održavao željenu temperaturu u prostoriji.



Turbo hlađenje

Poseban program omogućava motoru rad na većim frekvencijama. Omogućava korisnicima uživanje u željenoj temperaturi u znatno kraćem vremenu.



Ispuh dugog dometa

Unutarnja jedinica sa boljim motorom, optimiziranim ventilatorom i zračnim kanalom.



Jaki ispuh

S poboljšanim ventilatorom i zračnim kanalom, klima uređaj isporučuje 25% više volumena zraka.



Hyper PCB

Raspon radnog napona je 130V-264V. Može se pokrenuti na minimalno 130V i izdržati maksimalni skok napona od 450SV.



Antikoroziivna zaštita

Zaštita klima uređaja od oštećenja izazvanih ekstremnim uvjetima u priobalju gdje je visoka koncentracija vlage u zraku, slane vode, kemikalija i kiselina. Osigurava veću pouzdanost rada klima uređaja.

PREGLJED FUNKCIJA

Ultimativni komfor



Topli start

Prilikom grijanja ili promjene načina rada iz hlađenja u grijanje, klima uređaj ne ispuhuje hladni zrak u prostor.



-30°C grijanje

Visokoučinkovito grijanje pri vrlo niskim temperaturama. Osigurava stabilan učinak grijanja čak i u ekstremno hladnim uvjetima (temperature do -30°C).



-20°C grijanje

Osigurava jaki učinak grijanja u hladnim zimama zbog rotari kompresora, DC motora, optimizirane donje ploče, električnog grijača i specijalnog programa.



-15°C grijanje

Osigurava jaki učinak grijanja u hladnim zimama zbog rotari kompresora.



-10°C grijanje

Radi pri niskim temperaturama s visoko frekventnim rotari kompresorom, optimiziranim rashladnim sistemom i posebnim programom za odmrzavanje.



DC motor

Osigurava pouzdan rad uređaja s većom uštedom energije i nižom razinom buke.



DC kompresor

Reducira gubitak energije i maksimizira ulaz kako bi postigao što veću energetska učinkovitost.



Pametno odmrzavanje

Radi samo po potrebi zbog uštede energije i omogućava bolji rad uređaja smanjenjem vremena odmrzavanja.



5 stupanjski ventilator unutarnje jedinice

Radi u jakoj/visokoj/srednjoj/niskoj/tihoj brzini rada, te daje korisniku veći izbor mogućih brzina ispuha.



Dupla horizontalna krilca

Podržava strujanje zraka u više smjerova i poboljšava korisničko iskustvo.



Automatsko vertikalno strujanje zraka

Pomicanjem horizontalnih krilaca, usmjerava zrak vertikalno u više mogućih kutova.



3-minutna zaštita

Pomaže kompresoru izbjegavanje naglih izmjena opterećenja te mu time produžuje životni vijek.



Auto restart

Ukoliko dođe do nestanka struje, uređaj nastavlja rad po prethodno postavljenim postavkama.



Široki raspon radnog napona

Omogućava inverter klima uređaju rad od 150V-264V



88 ekran

U realnom vremenu prikazuje temperaturu prostorije ili željenu temperaturu.



Auto mod

Odabire automatski hlađenje ili grijanje, ovisno o temperaturi koja je zadana.



Integrirana struktura

Kombinira donji dio kućišta, kadicu odvoda kondenzata i cjelokupni oklop klima uređaja kako bi se smanjile vibracije i poboljšala pouzdanost.



10°C održavanje temperature

Kada temperatura u prostoru padne ispod 10°C, uključuje se grijanje kako bi se cijevi i instalacije zaštitile od smrzavanja.



1 Watt standby

Spušta potrošnju u stanju mirovanja sa 8W na samo 1W, optimizirajući rad programa.



Integriran poklopac ventila

Štiti blok terminal za priključne žice kao i priključne ventile te poboljšava estetiku vanjske jedinice.



Vanjski 7-stupanjski ventilator

Optimizira rad izmjenjivača temperature pomoću kontroliranih senzora, te na taj način poboljšava energetska učinkovitost.



Super tihi rad

Optimiziran rad ventilatora i motora pruža korisniku potpuni mir i tišinu.



Precizno odvlaživanje

Kontrolira razinu vlage u zraku kako bi održao zrak čistim i ugodnim.



Precizna kontrola temperature

Omogućuje podešavanje temperature s preciznošću od 0,5°C. Postiže se bolji komfor i veća ušteda energije.

PREGLJED FUNKCIJA

Ultimativni komfor



Funkcija isušivanja

Automatski prilagođava brzinu ventilatora prema temperaturi u prostoriji, kako bi se postiglo blago ili snažno isušivanje.



3D ispuh zraka

Omogućuje ugodno strujanje zraka do svih kutova prostorije, konstantnim pomicanjem krilca u horizontalnom i vertikalnom smjeru.



Inteligentan zrak (Low wind)

Usmjerava strujanje zraka prema gore u modu hlađenja, te prema dolje u modu grijanja, čime postiže bolji klimatizacijski učinak.
LOW WIND – Brzo postizanje željene temperature i održavanje bez propuha.



Ugodan san

Pružna maksimalan komfor i uštedu energije za miran san.



I Feel

Haier klima uređaj može točno detektirati i kontrolirati sobnu temperaturu u prostoriji u kojoj se nalazi upravljač.

Ultimativna fleksibilnost



Specifikacije pozicioniranja

Pomaže pri učvršćivanju montažne ploče i omogućava preciznu montažu klima uređaja.



Produžena montažna nožica

Laka montaža i održavanje klima uređaja zbog većeg operativnog prostora.



Jednostavan pristup kontrolnoj ploči

Pojednostavljuje pristup i održavanje kontrolne ploče bez rastavljanja kućišta.



Širi prostor cijevi

Štedi vrijeme instalacije većim prostorom za spajanje cijevi i žica.



Jednostavan pristup motoru ventilatora

Pojednostavljuje demontažu i održavanje, bez rastavljanja isparivača.



Odvojiv donji pokrov

Lako otvaranje dna kućišta bez odvijača, radi lakšeg spajanja cijevi i žica.



Jednostavno održavanje i servis

Optimizira strukturu unutarnje jedinice klima uređaja pojednostavljenim rastavljanjem osnovnih komponenti uključujući PC pločicu, motor i ventilator, čineći održavanje i čišćenje lakšim nego ikad prije.



Samo dijagnoza

Prikazuje Error kôd na LED ekranu unutarnje jedinice kako bi se olakšalo i ubrzalo održavanje.



Super match

Slobodno kombiniranje unutarnjih i vanjskih jedinica, radi lakšeg snalaženja u prodaji, analizama i evidenciji.



On-Off Card



























Omogućuje dodatnu uštedu i kontrolu nad klima uređajima koji se nalaze u hotelskim sobama ili apartmanima. Omogućava isključivanje/uključivanje klima uređaja s vanjskim kontaktom - ulazna vrata ili kod otvaranja ili zatvaranja prozora.



Central Control

Haier klima uređaji mogu se spojiti na centralizirani sustav upravljanja s više HVAC jedinica. Pametno upravljanje klima uređajem pojedinačno, grupno ili u zonama objekta.















PREDNOSTI

	Kategorije & funkcije		Expert - Nordic	Expert
Ultimativno zdravlje	Frost-Clean		●	●
	56°C sterilizacija		●	●
	Self-higiene			
	Easy to Clean		●	●
	UVC sterilizacija			
	UVC pro		●	●
	HAF Filter (3M Filter)		○	○
	Blue Fin		●	●
Ultimativne pametne funkcije	Glasovne kontrole		●	●
	WiFi kontrola		●	●
	Eco senzor		●	●
Ultimativni komfor	A-PAM Control		●	●
	PID Control		●	●
	Turbo hlađenje		●	●
	Ispuh dugog dometa			18k
	Jaki ispuh		●	●
	Hyper PCB		●	●
	Anti-Corrosion		●	●
	Topli start		●	●
	-20°C grijanje		●	●
	-15°C grijanje		●	●
	-10°C grijanje		●	●
	DC motor		●	●
	DC kompresor		●	●
	Pametno odmrzavanje		●	●
	5 stupanjski ventilator unutarnje jedinice		●	●
	Dupla horizontalna krilca			18k/24k

PREDNOSTI

Kategorije & funkcije			Expert - Nordic	Expert
Ultimativni komfor	Automatsko vertikalno strujanje zraka		●	●
	3 minutna zaštita		●	●
	Auto restart		●	●
	Široki raspon radnog napona		●	●
	88 ekran		●	●
	Auto mod		●	●
	Integrirana struktura		●	●
	10° C grijanje		●	●
	1 Watt standby		●	●
	Integriran poklopac ventila		●	●
	Vanjski 7-stupanjski ventilator		●	●
	Coanda Plus Airflow		●	●
	Super tihi rad		●	●
	Precizno odvlaživanje			
	Precizna kontrola temperature			
	Funkcija isušivanja		●	●
	3D ispuh zraka		●	●
	Inteligentan zrak		●	●
	Ugodan san		●	●
I Feel		●	●	
Ultimativna fleksibilnost	Specifikacije pozicioniranja		●	●
	Produžena montažna nožica		●	●
	Jednostavan pristup kontrolnoj ploči		●	●
	Širi prostor cijevi		●	●
	Jednostavan pristup motoru ventilatora		●	●
	Odvojiv donji dio unutarnje jedinice		●	●
	Jednostavno održavanje i servis		●	●
	Samo dijagnoza		●	●
	Super kombinacija			●
	On-Off Card		○	○
	Central Control		●	●

PREGLJED MODELA

Kategorija	Naziv modela		Remote Controller
INVERTER	Expert - Nordic		
	Expert		
	Flexis Plus		
	Pearl Premium		
	Pearl		
	Tundra Plus		
	Tide Plus		

Haier klima uređaji

9K	12K	18K	24K
•	•		
•	•	•	
•	•	•	•
•	•	•	•
•	•	•	•
•	•	•	•
•	•	•	•



reddot winner 2022



Adapter za žičani kontroler



Žičani kontroler (opcija)



■ PREDNOSTI



UVC Pro

Sprječava razmnožavanje bakterija i sterilizira viruse. Razgradnjom kationa vodika i molekula kisika stvara ionsku skupinu koja inhibira bakterije i sterilizira virus nakon kontakta.



3D ispuh zraka

Omogućuje ugodno strujanje zraka do svih kutova prostorije, konstantnim pomicanjem krilca u horizontalnom i vertikalnom smjeru.



-30°C grijanje

Visokoučinkovito grijanje pri vrlo niskim temperaturama. Osigurava stabilan učinak grijanja čak i u ekstremno hladnim uvjetima (temperature do -30°C).



56°C sterilizacija



I Feel



Frost Clean



Coanda Plus protok zraka



ECO senzor



Wi-Fi kontrola (hOn)



On-Off card



Easy to Clean

Popis svih funkcija za navedeni model nalazi se na stranicama 32. – 37.

Expert Nordic

Model	Unutarnja		AS25XCHHRA-NR	AS35XCHHRA-NR
	Vanjska		1U25KEHFRA-NR	1U35KEHFRA-NR
Hlađenje				
Kapacitet	Nominal (Min-Max)	Btu/h	8870(3410-11940)	11940(3410-15010)
	Nominal (Min-Max)	kW	2.6(1.00-3.50)	3.5
Energetska efikasnost	SEER/EER		8.5 / 4.5	8.5
Energetski razred			A+++	A+++
Pdesign kapacitet		kW	2.6	3.5
Snaga električnog priključka	Nominal (Min-Max)	kW	0.58(0.3-1.14)	0.82
Godišnja potrošnja energije		kWh/a	107	144
Temperaturni raspon rada	Min-Max	°C	-20-43°C(out)	-20-43°C(out)
Grijanje				
Kapacitet	Nominal (Min-Max)	Btu/h	10910(3410-25240)	14330(4430-26950)
Kapacitet	Nominal (Min-Max)	kW	3.2(1.0-7.4)	4.2(1.3-7.9)
Energetska efikasnost	SCOP/COP (Mild)		5.1	5.1
	SCOP (Warm/Cold)		5.1/3.8	5.1/3.8
Energetski razred	Mild/Warm/Cold		A+++ / A+++ / A	A+++ / A+++ / A
Pdesign kapacitet (-10°C)		kW	3.0	3.6
Snaga električnog priključka	Nominal (Min-Max)	kW	0.76(0.4-2.40)	1.0(0.4-2.40)
Godišnja potrošnja energije		kWh/a	824	988
Temperaturni raspon rada		°C	-30-24°C(out)	-30-24°C(out)
Napajanje	Ph/V/Hz		1/230/50	1/230/50
	Pozicija		Vanjska jedinica	Vanjska jedinica
Unutarnja jedinica				
Neto dimenzije	Š/D/V	mm	895/236/313	895/236/313
Dimenzije sa ambalažom	Š/D/V	mm	964/386/316	964/386/316
Neto/bruto težina		kg	12.4/14.8	12.4/14.8
Protok zraka	Max	m³/h	750	810
Razina zvučnog tlaka	Hlađenje (Hi/Mid/Lo/So)	dB(A)	42/32/24/18	43/33/24/18
	Grijanje (Hi/Mid/Lo/So)	dB(A)	42/32/24/18	43/33/24/18
Odvlaživanje		10-3m³/h	1.2	1.6
Vanjska jedinica				
Neto dimenzije	Š/D/V	mm	820/305/643	820/305/643
Dimenzije sa ambalažom	Š/D/V	mm	940/390/697	940/390/697
Neto/bruto težina		kg	35.7/38.5	35.7/38.5
Protok zraka	Max	m³/h	3200	3200
Razina zvučnog tlaka	Hi	dB(A)	62	63
Radna struja	Max	A	10.9	11.36
Vrsta radne tvari	R32		R32	R32
Količina radne tvari	R32	g	1100	1100
Promjeri cijevi	Tekućinski	mm	6.35	6.35
	Plinski	mm	9.52	9.52
	Max. dozvoljena duljina cjevovoda	m	20	20
	Max. visinska razlika	m	10	10
	Max. duljina cjevovoda bez nadopune	m	7	7
	Nadopuna po dodatnom metru	g/m	20	20
Razmak između nogica - informacije se nalaze u zadnjem dijelu kataloga.				



reddot winner 2022



Adapter za žičani kontroler



Žičani kontroler (opcija)



■ PREDNOSTI



UVC Pro

Sprječava razmnožavanje bakterija i sterilizira viruse. Razgradnjom kationa vodika i molekula kisika stvara ionsku skupinu koja inhibira bakterije i sterilizira virus nakon kontakta.



Easy to Clean

Inovacija za čist zrak koja omogućuje jednostavno vađenje ventilatora i filtera za dubinsko čišćenje klima uređaja.



56°C sterilizacija

Uništava bakterije i viruse zagrijavanjem isparivača na 56°C u trajanju od 30 minuta.



ECO senzor



Wi-Fi kontrola (hOn)



On-Off card



3D ispuh zraka



Jednostavna instalacija



I Feel



Frost Clean



Coanda Plus protok zraka

Popis svih funkcija za navedeni model nalazi se na stranicama 32. – 37.

Model	Unutarnja		AS25XCAHRA	AS35XCAHRA	AS50XCAHRA
	Vanjska		1U25S2SM1FA-2	1U35S2SM1FA-2	1U50S2S2J2FA-2
Hlađenje					
Kapacitet	Nominal (Min-Max)	Btu/h	9550(2730-10920)	11940(3410-13650)	17064(4770-18770)
	Nominal (Min-Max)	kW	2.8(0.8-3.2)	3.5(1.0-4.0)	5.0(1.4-5.5)
Energetska efikasnost	SEER/EER		8.8/4.3	8.5/4.00	6.6/3.4
Energetski razred			A+++	A+++	A++
Pdesign kapacitet		kW	2.8	3.5	5
Snaga električnog priključka	Nominal (Min-Max)	kW	0.65(0.2-1.2)	0.87(0.3-1.4)	1.47(0.5-2.0)
Godišnja potrošnja energije		kWh/a	111	144	265
Temperaturni raspon rada	Min-Max	°C	-20-43°C(out)	-20-43°C(out)	-20-43°C(out)
Grijanje					
Kapacitet	Nominal (Min-Max)	Btu/h	10920(2730-14330)	14330(3410-17740)	19110(5800-21160)
Kapacitet	Nominal (Min-Max)	kW	3.2(0.8-4.2)	4.2(1.0-5.2)	6.0(1.7-6.2)
Energetska efikasnost	SCOP/COP (Mild)		4.8/4.2	4.75/4.05	4.6/4.0
	SCOP (Warm/Cold)		5.1/-	5.1/-	5.1/-
Energetski razred	Mild/Warm/Cold		A++/A+++/-	A++/A+++/-	A++/A+++/A
Pdesign kapacitet (-10°C)		kW	2.5	2.8	4.6
Snaga električnog priključka	Nominal (Min-Max)	kW	0.76(0.3-1.5)	1.04(0.5-1.6)	1.51(0.52-2.3)
Godišnja potrošnja energije		kWh/a	737	825	1498
Temperaturni raspon rada		°C	-20-24°C(out)	-20-24°C(out)	-20-24°C(out)
Napajanje	Ph/V/Hz		1/220-240/50	1/220-240/50	1/220-240/50
	Polozicija		Vanjska jedinica	Vanjska jedinica	Vanjska jedinica
Unutarnja jedinica					
Neto dimenzije	Š/D/V	mm	895/236/313	895/236/313	895/236/313
Dimenzije sa ambalažom	Š/D/V	mm	964/316/386	964/316/386	964/316/386
Neto/bruto težina		kg	11.3/14	11.3/14	11.6/14.2
Protok zraka	Max	m³/h	730	800	880
Razina zvučnog tlaka	Hlađenje (Hi/Mid/Lo/So)	dB(A)	39/32/25/16	40/33/26/17	45/41/37/29
	Grijanje (Hi/Mid/Lo/So)	dB(A)	39/32/25/16	40/33/26/17	45/41/37/29
Odvlaživanje		10-3m³/h	1.2	1.6	2
Vanjska jedinica					
Neto dimenzije	Š/D/V	mm	800/280//553	800/280//553	820/305/643
Dimenzije sa ambalažom	Š/D/V	mm	902/375/614	902/375/614	940/390/697
Neto/bruto težina		kg	27.6/30.4	30/32.9	35.7/38.5
Protok zraka	Max	m³/h	2300	2400	3000
Razina zvučnog tlaka	Hi	dB(A)	59	61	63
Radna struja	Max	A	6.8	7.2	10.7
Vrsta radne tvari	R32		R32	R32	R32
Količina radne tvari	R32	g	630	780	1100
Promjeri cijevi	Tekućinski	mm	6.35	6.35	6.35
	Plinski	mm	9.52	9.52	12.7
	Max. dozvoljena duljina cjevovoda	m	20	20	25
	Max. visinska razlika	m	10	10	15
	Max. duljina cjevovoda bez nadopune	m	7	7	7
	Nadopuna po dodatnom metru	g/m	20	20	20
Razmak između nogica - informacije se nalaze u zadnjem dijelu kataloga.					



Adapter za žičani kontroler



Žičani kontroler (opcija)



■ PREDNOSTI



UVC sterilizacija

Emitira UV zrake te na taj način sterilizira zrak koji prolazi kroz klima uređaj s učinkovitošću od 99,9%.



56°C sterilizacija

Uništava bakterije i viruse zagrijavanjem isparivača na 56°C u trajanju od 30 minuta.



ECO senzor

Detektira stanje u prostoru, te ljudsku aktivnost u realnom vremenu, te prilagođava način rada kako bi postigao najbolju energetska učinkovitost i udobnost za korisnike.



Frost Clean



ECO senzor



Jednostavna instalacija



Super tihi rad



Wi-Fi kontrola (hOn)



I Feel



3D ispuh zraka



Širi prostor cijevi

Popis svih funkcija za navedeni model nalazi se na stranicama 32. – 37.

Flexis Plus

Haier

2,6 kW

3,5 kW

5,2 kW

7,0 kW

Model	Unutarnja		AS25S2SF1FA-BH AS25S2SF1FA-S AS25S2SF1FA-WH	AS35S2SF1FA-BH AS35S2SF1FA-S AS35S2SF1FA-WH	AS50S2SF1FA-BH AS50S2SF1FA-WH	AS71S2SF1FA-BH AS71S2SF1FA-WH
	Vanjska		1U25S2SM1FA-2	1U35S2SM1FA-2	1U50S2S2J2FA-2	1U71S2ST1FA
Hlađenje						
Kapacitet	Nominal (Min-Max)	Btu/h	8870 (2730-10920)	11940 (3410-13650)	17740 (4770-20470)	23890 (7510-25600)
	Nominal (Min-Max)	kW	2.6 (0.8-3.2)	3.5 (1.0-4.0)	5.2 (1.4-6.0)	7.0 (2.20-7.70)
Energetska efikasnost	SEER/EER		8.5/4.00	8.5/4.00	7.2/3.60	7.1/3.23
Energetski razred			A+++	A+++	A++	A++
Pdesign kapacitet		kW	2.6	3.5	5.2	7.0
Snaga električnog priključka	Nominal (Min-Max)	kW	0.65 (0.20-1.20)	0.87 (0.30-1.50)	1.4 (0.5-2.0)	2.17 (0.7-2.5)
Godišnja potrošnja energije		kWh/a	107	144	253	345
Temperaturni raspon rada	Min-Max	°C	-20-43°C (out)	-20-43°C (out)	-20-43°C (out)	-20-43°C (out)
Grijanje						
Kapacitet	Nominal (Min-Max)	Btu/h	10920 (2730-14330)	14330 (3410-17740)	20470 (4770-23540)	27300 (8190-29000)
Kapacitet	Nominal (Min-Max)	kW	3.2 (0.8-4.2)	4.2 (1.0-5.2)	6.0 (1.4-6.9)	8.0 (2.4-8.5)
Energetska efikasnost	SCOP/COP (Mild)		4.6/4.00	4.6/3.81	4.6/4.00	4.0/3.71
	SCOP (Warm/Cold)		5.1/-	5.1/-	5.1/3.4	5.1/-
Energetski razred	Mild/Warm/Cold		A++/A+++/-	A++/A+++/-	A++/A+++/A	A+/A+++/-
Pdesign (-10°C)		kW	2.4	2.8	4.6	5.6
Snaga električnog priključka	Nominal (Min-Max)	kW	0.8 (0.30-1.50)	1.1 (0.5-1.6)	1.5 (0.5-2.35)	2.16 (0.7-2.9)
Godišnja potrošnja energije		kWh/a	731	854	1400	1959
Temperaturni raspon rada		°C	-20-24°C (out)	-20-24°C (out)	-20-24°C (out)	-20-24°C (out)
Napajanje	Ph/V/Hz		1/220-240/50	1/220-240/50	1/220-240/50	1/230/50
	Pozicija		Vanjska jedinica	Vanjska jedinica	Vanjska jedinica	Vanjska jedinica
Unutarnja jedinica						
Neto dimenzije	Š / D / V	mm	856/197/300	856/197/300	999/225/323	1115/235/343
Dimenzije sa ambalažom	Š / D / V	mm	952/283/389	952/283/389	1100/314/420	1202/319/432
Neto/bruto težina		kg	9.5/12	9.5/12	12/15	15.2/18.2
Protok zraka	Max	m³/h	600	650	900	1100
Razina zvučnog tlaka	Hlađenje (Hi/Mid/Lo/So)	dB(A)	38/32/25/16	39/33/26/17	45/41/37/28	47/43/37/33
	Grijanje (Hi/Mid/Lo/So)	dB(A)	38/32/25/19	39/33/26/20	45/41/37/28	47/43/37/33
Odvlaživanje		10-3m³/h	1.2	1.6	2	2.8
Vanjska jedinica						
Neto dimenzije	Š / D / V	mm	800/280/553	800/280/553	820/306/642	890/340/705
Dimenzije sa ambalažom	Š / D / V	mm	902/375/607	902/375/607	940/390/697	1046/460/780
Neto/bruto težina		kg	27.6/30.4	30/32.9	37.8/40.5	44/48
Protok zraka	Max	m³/h	1900	2000	3000	3600
Razina zvučnog tlaka	Hi	dB(A)	59	61	63	70
Radna struja	Max	A	6.8	7.2	10.7	13
Vrsta radne tvari	R32		R32	R32	R32	R32
Količina radne tvari	R32	g	630	780	1100	1230
Promjeri cijevi	Tekućinski	mm	6.35	6.35	6.35	9.52
	Plinski	mm	9.52	9.52	12.7	15.88
	Max. dozvoljena duljina cjevovoda	m	20	20	25	25
	Max. visinska razlika	m	10	0	15	15
	Max. duljina cjevovoda bez nadopune	m	7	7	7	7
Nadopuna po dodatnom metru	g/m		20	20	20	45

Razmak između nogica - informacije se nalaze u zadnjem dijelu kataloga.



Adapter za
žičani kontroler

Žičani kontroler
(opcija)

■ PREDNOSTI



Super grijanje



UVC Pro

Sprječava razmnožavanje bakterija i sterilizira viruse. Razgradnjom kationa vodika i molekula kisika stvara ionsku skupinu koja inhibira bakterije i sterilizira virus nakon kontakta.



56°C sterilizacija

Ubija bakterije i viruse zagrijavanjem isparivača na 56°C u trajanju od 30 minuta.



Coanda P lus
protok zraka



Super tihi rad



3D ispuh zraka



I Feel



WI-FI kontrola
(hOn)



Jednostavna
instalacija

Popis svih funkcija za navedeni model nalazi se na stranicama 32. – 37.

Pearl Premium

Model	Unutarnja		AS25PBPHRA-PRE	AS35PBPHRA-PRE	AS50DPHRA-PRE	AS71PEPHRA-PRE
	Vanjska		1U25YEPFRA-H	1U35MEPFRA-H	1U50KEPFRA-H	1U71WEPFRA-H
Hlađenje						
Kapacitet	Nominal (Min-Max)	Btu/h	9215(2730-12280)	12285(2730-13650)	18080(6820-21495)	24225(7165-27295)
	Nominal (Min-Max)	kW	2.70	3.60	5.30	7.10
	Range (Min-Max)	kW	(0.80-3.60)	(0.80-4.00)	(2.0-6.3)	(2.1-8.0)
Energetska efikasnost	SEER/EER		8.5	8.5	8.50	8.50
Energetski razred			A+++	A+++	A+++	A+++
Pdesign kapacitet		kW	2.70	3.30	5.30	7.10
Snaga električnog priključka	Nominal (Min-Max)	kW	0.711	1.114	1.510	1.970
		kW	(0.400-1.060)	(0.40-1.310)	(0.21-2.2)	(0.32-2.9)
Godišnja potrošnja energije		kWh/a	111	136	218	292
Temperaturni raspon rada	Min-Max	°C	-20-43°C(out)	-20-43°C(out)	-20-43°C(out)	-20-43°C(out)
Grijanje						
Kapacitet	Nominal (Min-Max)	Btu/h	10570(2730-14660)	13300(2730-15350)	19970(4605-23200)	25250(5120-29000)
Kapacitet	Nominal (Min-Max)	kW	3.10	3.90	5.80	7.40
Kapacitet	Range (Min-Max)	kW	(0.80-4.30)	(0.80-4.50)	(1.35-6.8)	(1.5-8.5)
Energetska efikasnost	SCOP		4.6	4.6	4.60	4.60
Energetska efikasnost	COP (Mild)		3.71	3.71	4.00	3.80
Energetska efikasnost	SCOP (Warm/Cold)		5.1/-	5.1/-	5.40/-	5.40/-
Energetski razred	Mild/Warm/Cold		A++/A+++/-	A++/A+++/-	A++/A+++/-	A++/A+++/-
Pdesign (-10°C)		kW	2.40	2.80	4.60	5.60
Snaga električnog priključka	Nominal	kW	0.835	1.051	1.450	1.950
	Range (Min-Max)	kW	0.400-1.390	0.40-1.530	(0.5-2.7)	(0.6-3.2)
Godišnja potrošnja energije		kWh/a	730	852	1400	1704
Temperaturni raspon rada		°C	-25-24°C(out)	-25-24°C(out)	-25-24°C(out)	-25-24°C(out)
Napajanje	Ph/V/Hz		1/220-240/50	1/220-240/50	1/220-240/50	1/220-240/50
	Pozicija		Vanjska jedinica	Vanjska jedinica	Vanjska jedinica	Vanjska jedinica
Unutarnja jedinica						
Neto dimenzije	Š / D / V	mm	805/292/200	805/292/200	975/220/318	1105/240/335
Dimenzije sa ambalažom	Š / D / V	mm	876/365/272	876/365/272	1050/397/301	1185/428/331
Neto/bruto težina		kg	8.1/10.3	8.6/10.8	11.6/14.4	15.4/18.9
Protok zraka	Max	m³/h	610/550	670/670	930/980	1180/1140
Razina zvučnog tlaka	Hlađenje (Hi/Mid/Lo/So)	dB(A)	37/32/28/18	38/33/29/18	44/40/36/31	48/42/35/27
	Grijanje (Hi/Mid/Lo/So)	dB(A)	37/32/28/18	38/33/29/18	44/40/36/31	48/42/35/27
Odvlaživanje		10-3m³/h	1.2	1.4	2.3	3.0
Vanjska jedinica						
Neto dimenzije	Š / D / V	mm	700/245/544	800/280/553	820/306/642	890/340/705
Dimenzije sa ambalažom	Š / D / V	mm	819/320/592	902/375/614	940/390/697	1046/460/780
Neto/bruto težina		kg	24.6/27	28.5/31.4	37.8/40.5	43.0/47.0
Protok zraka	Max	m³/h	2100	2300	2700	3000
Razina zvučnog tlaka	Hi	dB(A)	62	65	65	70
Radna struja	Max	A	6.31	6.95	12.3	14.5
Vrsta radne tvari	R410a/R32		R32	R32	R32	R32
Količina radne tvari	R410a/R32	g	580	650	1100	1350
Promjeri cijevi	Tekućinski	mm	6.35	6.35	6.35	6.35
	Plinski	mm	9.52	9.52	12.7	15.88
	Max. dozvoljena duljina cjevovoda	m	20	20	25	25
	Max. visinska razlika	m	10	10	15	15
	Max. duljina cjevovoda bez nadopune	m	7	7	7	7
	Nadopuna po dodatnom metru	g/m	20	20	20	20
Razmak između nogica - informacije se nalaze u zadnjem dijelu kataloga.						



Adapter za
žičani kontroler

Žičani
kontroler
(opcija)

■ PREDNOSTI



UVC sterilizacija
Emitira UV zrake te na taj način sterilizira zrak koji prolazi kroz klima uređaj s učinkovitošću od 99,9%.



56°C sterilizacija
Ubija bakterije i viruse zagrijavanjem isparivača na 56°C u trajanju od 30 minuta.



Coanda Plus protok zraka
Osigurava dalji, brži i jači ispuh zraka iz klima uređaja, kako bi zrak bio jednakomjerno raspodijeljen po cijeloj prostoriji.

Popis svih funkcija za navedeni model nalazi se na stranicama 32. – 37.



Super grijanje



Super tihi rad



Auto restart



On-Off card



Wi-Fi kontrola
(hOn)



Jednostavna
instalacija

Pearl

Model	Unutarnja		AS25PBAHRA	AS35PBAHRA	AS50PDAHRA	AS68PDAHRA
	Vanjska		1U25YEGFRA-H1	1U35YEGFRA-H1	1U50MEGFRA-H	1U68WEGFRA
Hlađenje						
Kapacitet	Nominal (Min-Max)	Btu/h	8870(2730-10238)	11940(2730-12286)	17060(4430-19790)	23200(7500-29000)
	Nominal (Min-Max)	kW	2.6(0.8-3.0)	3.5(0.8-3.6)	5.0(1.3-5.8)	6.80(2.20-8.50)
Energetska efikasnost	SEER/EER		6.1/3.23	6.1/2.9	6.1/3.23	6.80/3.23
Energetski razred			A++	A++	A++	A++
Pdesign kapacitet		kW	2.6	3.5	5.0	6.80
Snaga električnog priključka	Nominal (Min-Max)	kW	0.8(0.3-1.2)	1.21(0.3-1.6)	1.55(0.4-2.0)	2.10(0.70-2.90)
Godišnja potrošnja energije		kWh/a	149	201	287	350
Temperaturni raspon rada	Min-Max	°C	-10-43°C (out)	-10-43°C (out)	-10-43°C (out)	-10-43°C (out)
Grijanje						
Kapacitet	Nominal (Min-Max)	Btu/h	9555(2730-10920)	11940(2730-14330)	17740(4770-20470)	23200(8180-32410)
Kapacitet	Nominal (Min-Max)	kW	2.8(0.8-3.2)	3.5(0.8-4.2)	5.2(1.4-6.0)	6.8(2.40-9.50)
Energetska efikasnost	SCOP/COP (Mild)		4.0/3.71	4.0/3.71	4.0/3.71	4.0/3.71
	SCOP (Warm/Cold)		5.1/-	5.1/-	5.1/-	5.10/-
Energetski razred	Mild/Warm/Cold		A+/A+++/-	A+/A+++/-	A+/A+++/-	A+/A+++/-
Pdesign (-10°C)		kW	2.4	2.8	4.6	5.60
Snaga električnog priključka	Nominal (Min-Max)	kW	0.75(0.3-1.4)	0.94(0.3-1.6)	1.4(0.52-2.5)	1.8(0.60-2.90)
Godišnja potrošnja energije		kWh/a	840	980	1610	1960
Temperaturni raspon rada		°C	-20-24°C (out)	-20-24°C (out)	-20-24°C (out)	-15-24°C (out)
Napajanje	Ph/V/Hz		1/220-240/50	1/220-240/50	1/220-240/50	1/220-240/50
	Pozicija		Vanjska jedinica	Vanjska jedinica	Vanjska jedinica	Vanjska jedinica
Unutarnja jedinica						
Neto dimenzije	Š / D / V	mm	805/200/292	805/200/292	975/220/318	975/220/318
Dimenzije sa ambalažom	Š / D / V	mm	876/272/365	876/272/365	1050/301/397	1050/301/397
Neto/bruto težina		kg	8.3/10.5	8.3/10.5	11.6/14.4	11.6/14.4
Protok zraka	Max	m³/h	550	600	900	1100
Razina zvučnog tlaka	Hlađenje (Hi/Mid/Lo/So)	dB(A)	37/32/28/18	37/33/29/19	44/40/35/28	47/45/37/29
	Grijanje (Hi/Mid/Lo/So)	dB(A)	37/32/28/18	37/33/29/19	44/40/35/28	47/45/37/29
Odvlaživanje		10-3m³/h	1.2	1.4	2	2.8
Vanjska jedinica						
Neto dimenzije	Š / D / V	mm	700/245/544	700/245/544	800/280/553	890/340/705
Dimenzije sa ambalažom	Š / D / V	mm	819/320/592	819/320/592	902/375/614	1046/460/780
Neto/bruto težina		kg	22.8/25.3	23.6/26.1	32.7/36.5	44/48
Protok zraka	Max	m³/h	2100	2100	2500	2600
Razina zvučnog tlaka	Hi	dB(A)	62	63	65	68
Radna struja	Max	A	6.2	7.1	11.3	13
Vrsta radne tvari	R410a/R32		R32	R32	R32	R32
Količina radne tvari	R410a/R32	g	520	530	900	1100
Promjeri cijevi	Tekućinski	mm	6.35	6.35	6.35	6.35
	Plinski	mm	9.52	9.52	12.7	12.7
	Max. dozvoljena duljina cjevovoda	m	20	20	25	25
	Max. visinska razlika	m	10	10	15	15
	Max. duljina cjevovoda bez nadopune	m	5	5	7	7
	Nadopuna po dodatnom metru	g/m	20	20	20	20
Razmak između nogica - informacije se nalaze u zadnjem dijelu kataloga.						



■ PREDNOSTI



Frost Clean

Smrzava isparivač pomoću vlage iz zraka, te na taj način veže čestice nečistoće i otapanjem ih uklanja kroz odvod kondenzata, dok na ispuhu osigurava čisti zrak.



PID control

Maksimizira radnu frekvenciju kako bi u što kraćem roku postigao željenu temperaturu prostora, a nakon toga u realnom vremenu stalno prilagođava frekvenciju uređaja kako bi održavao željenu temperaturu u prostoriji.



Super tihi rad

Optimiziran rad ventilatora i motora pruža korisniku potpuni mir i tišinu.



Frost Clean



Inteligentan zrak



Ugodan san



Super tihi rad



Wi-Fi kontrola (hOn)



-15°C grijanje



On-Off card



Produžena montažna nožica

Popis svih funkcija za navedeni model nalazi se na stranicama 32. – 37.

Tundra Plus

Model	Unutarnja		AS25TAEHRA-THC	AS35TADHRA-THC	AS50TDDHRA-THC	AS68TDRHRA-THC
	Vanjska		1U25YEFFRA-1	1U35MEEFRA-1	1U50MEGFRA	1U68WEGFRA-C
Hlađenje						
Kapacitet	Nominal (Min-Max)	Btu/h	8870(2730-10238)	12280(3410-13650)	17060(4430-19790)	23200(7500-29000)
	Nominal (Min-Max)	kW	2.6(0.8-3.4)	3.6(1.0-4.0)	5.0(1.3-5.8)	6.8(2.2-8.5)
Energetska efikasnost	SEER/EER		6.2/3.23	6.4/3.23	6.1/3.41	6.8/3.23
Energetski razred			A++	A++	A++	A++
Pdesign kapacitet		kW	2.6	3.6	5.0	6.8
Snaga električnog priključka	Nominal (Min-Max)	kW	0.8(0.3-1.2)	1.1(0.3-1.50)	1.47(0.40-2.00)	2.1(0.70-2.90)
Godišnja potrošnja energije		kWh/a	147	197	287	350
Temperaturni raspon rada	Min-Max	°C	-10-43°C (out)	-10-43°C (out)	-10-43°C (out)	-15-43°C (out)
Grijanje						
Kapacitet	Nominal (Min-Max)	Btu/h	9890(3410-12970)	12620(3750-15690)	17740(4770-20470)	23200(8180-32410)
Kapacitet	Nominal (Min-Max)	kW	2.9(1.0-3.8)	3.7(1.1-4.6)	5.2(1.4-6.0)	6.8(2.40-9.50)
Energetska efikasnost	SCOP/COP (Mild)		4.1/3.71	4.1/3.71	4.0/3.71	4.0/3.71
	SCOP (Warm/Cold)		5.1//	5.1/-	5.1/-	5.1/-
Energetski razred	Mild/Warm/Cold		A+/A+++//	A+/A+++/-	A+/A+++/-	A+/A+++/-
Pdesign (-10°C)		kW	2.4	3.2	4.6	5.6
Snaga električnog priključka	Nominal (Min-Max)	kW	0.78(0.3-1.4)	0.99(0.40-1.50)	1.40(0.52-2.5)	1.83(0.60-2.90)
Godišnja potrošnja energije		kWh/a	819	1092	1610	1960
Temperaturni raspon rada		°C	-15-24°C (out)	-15-24°C (out)	-15-24°C (out)	-15-24°C (out)
Napajanje	Ph/V/Hz		1/230/50	1/230/50	1/230/50	1/220-240/50
	Pozicija		Vanjska jedinica	Vanjska jedinica	Vanjska jedinica	Vanjska jedinica
Unutarnja jedinica						
Neto dimenzije	Š / D / V	mm	820/195/280	820/195/280	1008/225/318	1008/225/318
Dimenzije sa ambalažom	Š / D / V	mm	883/269/342	883/269/342	1085/329/403	1085/329/403
Neto/bruto težina		kg	8.4/10.5	8.4/10.5	11.6/14.4	11.6/14.4
Protok zraka	Max	m³/h	500	550	900	1100
Razina zvučnog tlaka	Hlađenje (Hi/Mid/Lo/So)	dB(A)	37/32/28/20	38/33/29/21	44/40/35/28	48/44/38/33
	Grijanje (Hi/Mid/Lo/So)	dB(A)	37/32/28/20	38/33/29/21	44/40/35/28	48/44/38/33
Odvlaživanje		10-3m³/h	1.2	1.6	2.0	2.8
Vanjska jedinica						
Neto dimenzije	Š / D / V	mm	700/245/544	800/280/553	800/280/553	890/340/705
Dimenzije sa ambalažom	Š / D / V	mm	819/320/592	902/375/614	902/375/614	1010/440/764
Neto/bruto težina		kg	22.8/25.3	27/30.3	32.7/36.5	44/48
Protok zraka	Max	m³/h	2100	2000	2500	2600
Razina zvučnog tlaka	Hi	dB(A)	62	63	65	68
Radna struja	Max	A	6.2	6.7	11.3	13
Vrsta radne tvari	R32		R32	R32	R32	R32
Količina radne tvari	R32	g	510	620	900	1100
Promjeri cijevi	Tekućinski	mm	6.35	6.35	6.35	6.35
	Plinski	mm	9.52	9.52	12.7	12.7
	Max. dozvoljena duljina cjevovoda	m	20	20	25	25
	Max. visinska razlika	m	10	10	15	15
	Max. duljina cjevovoda bez nadopune	m	5	5	7	7
	Nadopuna po dodatnom metru	g/m	20	20	20	20
Razmak između nogica - informacije se nalaze u zadnjem dijelu kataloga.						



■ PREDNOSTI



Frost Clean

Smrzava isparivač pomoću vlage iz zraka, te na taj način veže čestice nečistoće i otapanjem ih uklanja kroz odvod kondenzata, dok na ispuhu osigurava čisti zrak.



Super tihi rad

Optimiziran rad ventilatora i motora pruža korisniku potpuni mir i tišinu.



Wi-Fi kontrola

Preuzimanjem Haier hOn aplikacije na pametni uređaj (Apple ili Android), omogućuje se upravljanje i kontrola klima uređaja s bilo koje lokacije i bilo kada.



Topli start



Frost Clean



Inteligentan zrak



Ugodan san



Funkcija isušivanja



-15°C grijanje



Turbo hlađenje



Produžena montažna nožica

Popis svih funkcija za navedeni model nalazi se na stranicama 32. – 37.

Tide Plus

Model	Unutarnja		AS25THMHRA-C	AS35TAMHRA-C	AS50TDMHRA-C	AS68TDRHRA-C
	Vanjska		1U25YEFFRA-C	1U35YEFFRA-C	1U50MEMFRA-C	1U68WEGFRA-C
Hlađenje						
Kapacitet	Nominal (Min-Max)	Btu/h	8870(2730-10238)	10920(2730-12286)	17060(4430-19790)	23200(7500-29000)
	Nominal (Min-Max)	kW	2.6(0.8-3.0)	3.2(0.8-3.6)	5.0(1.3-5.8)	6.80(2.20-8.50)
Energetska efikasnost	SEER/EER		6.1/3.23	6.1/3.01	6.1/3.41	6.8/3.23
Energetski razred			A++	A++	A++	A++
Pdesign kapacitet		kW	2.6	3.2	5.0	6.8
Snaga električnog priključka	Nominal (Min-Max)	kW	0.8(0.3-1.2)	1.06(0.3-1.6)	1.47(0.40-2.0)	2.10(0.70-2.90)
Godišnja potrošnja energije		kWh/a	149	184	287	350
Temperaturni raspon rada	Min-Max	°C	-10-43°C (out)	-10-43°C (out)	-10-43°C (out)	-15-43°C (out)
Grijanje						
Kapacitet	Nominal (Min-Max)	Btu/h	9555(2730-10920)	11603(2730-14330)	17740(4770-20470)	23200(8180-32410)
Kapacitet	Nominal (Min-Max)	kW	2.8(0.8-3.2)	3.4(0.8-4.2)	5.2(1.4-6.0)	6.8(2.40-9.50)
Energetska efikasnost	SCOP/COP (Mild)		4/3.71	4/3.40	4.0/3.71	4.0/3.71
	SCOP (Warm/Cold)		5.1/-	5.1/-	5.10/-	5.10/-
Energetski razred	Mild/Warm/Cold		A+/A+++/-	A+/A+++/-	A+/A+++/-	A+/A+++/-
Pdesign (-10°C)		kW	2.4	2.8	4.60	5.60
Snaga električnog priključka	Nominal (Min-Max)	kW	0.75(0.3-1.4)	1.0(0.3-1.6)	1.4(0.52-2.50)	1.8(0.60-2.90)
Godišnja potrošnja energije		kWh/a	840	980	1610	1960
Temperaturni raspon rada		°C	-15-24°C (out)	-15-24°C (out)	-15-24°C (out)	-15-24°C (out)
Napajanje	Ph/V/Hz		1/220-240/50	1/220-240/50	1/220-240/50	1/220-240/50
	Pozicija		Vanjska jedinica	Vanjska jedinica	Vanjska jedinica	Vanjska jedinica
Unutarnja jedinica						
Neto dimenzije	Š / D / V	mm	820/195/280	820/195/280	1008/225/318	1008/225/318
Dimenzije sa ambalažom	Š / D / V	mm	883/269/342	883/269/342	1085/329/403	1085/329/403
Neto/bruto težina		kg	8.2/10.5	8.2/10.5	11.6/14.4	11.6/14.4
Protok zraka	Max	m³/h	500	550	900	1100
Razina zvučnog tlaka	Hlađenje (Hi/Mid/Lo/So)	dB(A)	37/33/29/19	38/34/29/20	44/40/35/28	48/44/38/33
	Grijanje (Hi/Mid/Lo/So)	dB(A)	37/33/29/19	38/34/29/20	44/40/35/28	48/44/38/33
Odvlaživanje		10-3m³/h	1	1.4	2.0	2.8
Vanjska jedinica						
Neto dimenzije	Š / D / V	mm	700/245/544	700/245/544	800/280/553	890/340/705
Dimenzije sa ambalažom	Š / D / V	mm	819/320/592	819/320/592	902/375/614	1010/440/764
Neto/bruto težina		kg	22.8/25.3	23.5/26	32.7/36.5	44/48
Protok zraka	Max	m³/h	2100	2100	2500	2600
Razina zvučnog tlaka	Hi	dB(A)	62	63	65	68
Radna struja	Max	A	6.2	7.1	11.3	13
Vrsta radne tvari	R32		R32	R32	R32	R32
Količina radne tvari	R32	g	510	530	900	1100
Promjeri cijevi	Tekućinski	mm	6.35	6.35	6.35	6.35
	Plinski	mm	9.52	9.52	12.7	12.7
	Max. dozvoljena duljina cjevovoda	m	20	20	25	25
	Max. visinska razlika	m	10	10	15	15
	Max. duljina cjevovoda bez nadopune	m	5	5	7	7
	Nadopuna po dodatnom metru	g/m	20	20	20	20
Razmak između nogica - informacije se nalaze u zadnjem dijelu kataloga.						



■ PREDNOSTI

Dizajn	Pametne značajke	Ugodno korisničko iskustvo	Performanse
Inovativan i kompaktan dizajn.	Hladi cijelu prostoriju uz pomoć funkcije automatskog usmjeravanja strujanja zraka.	Dvosmjerni odvod kondenzata. Dostupne opcije: automatski/ručno.	Jedinica se može koristiti kao klima uređaj / ventilator/odvlaživač zraka u svim vrstama prostora.
LED display.	Otvor za izlaz zraka automatski se otvara i zatvara pritiskom tipke on/off.	Kotačići za jednostavno premještanje uređaja.	Snažan kapacitet hlađenja. Jak ispuh zraka (350m ³ /h *model AM09AA1GAA).
Ergonomski dizajn upravljačke ploče.	Prikaz greške koda u slučaju kvara uređaja radi lakšeg i bržeg održavanje (Samo dijagnoza).	Držač za namatanje kabela za napajanje osigurava jednostavnu pohranu uređaja.	Tihi rad 48 dB (A) pri niskoj brzini rada ventilatora.
	Postavljanje vremena nakon kojeg će se uređaj uključiti/isključiti (24h Timer).	Kadica za skupljanje kondenzata.	

Mobilni klima uređaj



MOBILNI KLIMA UREĐAJ		AM09AA1GAA	AM12AA1GAA
Kapacitet (hlađenje)	kW	2.6	3.5
Kapacitet (grijanje)	kW	2.9	3.3
Energetska efikasnost/razred	EER	A(2.61)	A(2.61)
Energetska efikasnost/razred	COP	2.8	A(2.75)
Snaga električkog priključka	kW	1.01	1.01
Radna struja (max.)	A	4.8	5.9
Napajanje	Ph/V/HZ	1/220-240/50	1/220-240/50
Neto dimenzije (ŠxDxV)	mm	443x340x815	443x340x815
Dimenzije s ambalažom (ŠxDxV)	mm	480x435x880	480x435x880
Neto/Bruto težina	kg	25/30	28/33
Protok zraka (max.)	m ³ /h	350	350
Vrsta radne tvari		R290	R290
Količina radne tvari	g	235	245
Odvlaživanje	L/h	0,9	1,2
Razina buke/zvučna snaga (Hi/Mid/Lo)	dB(A)	56/54/52	56/54/52
Duljina kabela	m	1	1
Duljina cijevi za odvod	m	1	1
Promjer cijevi za odvod	cm	12	12



A+++



R32 SUPER MATCH MULTI SUSTAVI

Multi split klima uređaji Haier pravi su odabir za one koji žele klimatizirati više prostorija u domu ili u objektima komercijalne namjene.











Predstavljaju idealno estetsko i konstrukcijsko rješenje za grijanje i hlađenje više prostorija: za veće stambene ili poslovne prostore, apartmane, hotele, restorane itd.

Opcije unutarnjih jedinica su zidna, kazetna i podna, različitih raspona snage, ovisno o preferencijama i potrebama korisnika.

- unutarnje jedinice mogu biti različitih tipova ugradnje i međusobno različitih kapaciteta
- individualno upravljanje ili grupno













PREGLED MODELA

SERIJA	2,5 kW	3,5 kW
Expert	 <p>AS25XCAHRA</p>	 <p>AS35XCAHRA</p>
Flexis Plus	 <p>AS25S2SF1FA-WH S25S2SF1FA-S AS25S2SF1FA-BH</p>	 <p>AS35S2SF1FA-WH AS35S2SF1FA-S AS35S2SF1FA-BH</p>
Pearl	 <p>AS25PBAHRA</p>	 <p>AS35PBAHRA</p>
Tundra	 <p>AS25TAEHRA-THC</p>	 <p>AS35TADHRA-THC</p>
Tide	 <p>AS25THMHRA-C</p>	 <p>AS35TAMHRA-C</p>



Multi split R32















5 kW	7,1 kW		
 <p>AS50XCAHRA</p>			
 <p>AS50S2SF1FA-WH AS50S2SF1FA-BH</p>	 <p>AS71S2SF1FA-WH AS71S2SF1FA-BH</p>		
 <p>AS50PDAHRA</p>	 <p>AS68PDAHRA</p>		
 <p>AS50TDDHRA-THC</p>	 <p>AS68TDRHRA-THC</p>		
 <p>AS50TDMHRA-C</p>	 <p>AS68TDRHRA-C</p>		

PREGLJED MODELA

SERIJA	2,5 kW	3,5 kW		
Kompaktni kazetni model - mini (panel: PB620 KB(H))	 AB25S2SC2FA (H)	 AB35S2SC2FA (H)		
Kompaktni kazetni model - (panel: PB620 KB(H))	 AB25S2SG2FA (H)	 AB35S2SG2FA (H)		
360° kazetni model PB-950QB(H)	●	●		
Slim kanalni model (niski ESP)	 AD25S2SS1FA(H) Panel: P1B-890IA/D (opcija)	 AD35S2SS1FA(H) Panel: P1B-890IA/D (opcija)		
Slim kanalni model (srednji ESP)	●	 AD35S2SM9FA(H)		
Podnostropni model	●	 AC35S2SG2FA(H)		
Podni inverter model	 AF25S2SD1FA(D)	 AF35S2SD1FA(D)		
	5,0 kW	5,5 kW	7,0 kW	7,5 kW
VANJSKE JEDINICE	 2U50S2SM1FA-3	 3U55S2SR5FA	 3U70S2SR5FA	 4U75S2SR5FA



Multi split R32

4,2 kW		5 kW		7,1 kW			
	•	 AB50S2SC2FA (H)		•			
	•	 AB50S2SG2FA (H)		•			
	•	•		 AB71S2SR1FA(H)			
	•	 AD50S2SS1FA (H) Panel: P1B-1210IA/D (opcija)		 AD71S2SS1FA (H) Panel: P1B-1210IA/D (opcija)			
	•	 AD50S2SM9FA(H)		 AD71S2SM9FA(H)			
	•	 AC50S2SG2FA(H)		 AC71S2SG2FA(H)			
 AF42S2SD1FA(D)		•		•			
8,5 kW		9,0 kW		10,5 kW		12,5 kW	
 4U85S2SR5FA	 5U90S2SS5FA	 5U105S2SS5FA	 5U125S2SN1FA				

Multi inverter



Model		2U50S2SM1FA	3U55S2SR5FA	3U70S2SR5FA
Maksimalan broj unutarnjih jedinica		2	3	3
Kapacitet - hlađenje	kW	5.0	5.0(2.1-6.6)	7.0(2.4-7.6)
Kapacitet - grijanje	kW	5.7	6.4(1.7-7.2)	7.6(2.9-8.5)
SEER / SCOP		6.5/4.0	8.5/4.6	8.5/4.6
Energetska klasa (grijanje / hlađenje)		A++/A+	A+++/A++	A+++/A++
Napajanje	PhV/Hz	1/230/50		1/220-240/50/60
Protok zraka (H/M/L)	m³/h	2200	≈3000	≈3000
Razina buke - zvučna snaga H/M/L	db(A)	62	64	66
Razina zvučnog tlaka H/M/L	db(A)	56	51	53
Vanjske dimenzije W/D/H	mm	800/275/553	890/340/700	890/340/700
Neto / Bruto težina	kg	34/37	50/59	54/63
Radna tvar		R32	R32	R32
Promjer cijevi tekućinski	mm	2×6.35	3×6.35	3×6.35
Promjer cijevi plinski	mm	2×9.52	3×9.52	3×9.52
Maksimalna duljina cjevovoda	m	30	50	60
Maksimalna duljina cjevovoda bez nadopune	m	20	30	30
Nadopuna po dodatnom metru	g/m	20	20	20
Maksimalna visinska razlika	m	15	15	15
Temperaturni raspon rada - hlađenje	°C	-10~46	-10~46	-10~46
Temperaturni raspon rada - grijanje	°C	-15~24	-15~24	-15~24
Razmak između nogica	mm	510	630	630

KOMBINACIJE SPAJANJA UNUTARNJIH I VANJSKIH JEDINICA

Multi R32					2 unutarnje jedinice							3 unutarnje jedinice													
Broj unutarnjih jedinica	2	3	4	5	9	9	9	9	12	12	12	12	18	18	24	24	9	9	9	9	9	9	9		
						9	12	18	24	12	18	24	18	24	24	24	9	9	9	9	9	12	12	12	
						-	-	-	-	-	-	-	-	-	-	-	9	12	18	24	12	18	18	24	
						-	-	-	-	-	-	-	-	-	-	-	-	-	-	-	-	-	-	-	
						-	-	-	-	-	-	-	-	-	-	-	-	-	-	-	-	-	-	-	
Vanjska jedinica	2U50S2SM1FA	*	*			*											*								
	3U55S2SR5FA	*	*	*		*											*								
	3U70S2SR5FA	*	*	*		*	*										*	*			*				
	4U75S2SR5FA	*	*	*	*	*	*	*	*	*	*	*	*	*	*	*	*	*	*	*	*	*	*	*	*
	4U85S2SR5FA	*	*	*		*	*	*	*	*	*	*	*	*	*	*	*	*	*	*	*	*	*	*	*
	5U90S2SS5FA	*	*	*	*	*	*	*	*	*	*	*	*	*	*	*	*	*	*	*	*	*	*	*	*
	5U105S2SS5FA	*	*	*	*	*	*	*	*	*	*	*	*	*	*	*	*	*	*	*	*	*	*	*	*
5U125S2SN1FA	*	*	*	*	*	*	*	*	*	*	*	*	*	*	*	*	*	*	*	*	*	*	*	*	

*Obavezno prije kupnje Multi invertera opcije (Super Match) potrebno je provjeriti tehničke specifikacije i mogućnosti instalacije s ovlaštenim Haier serviserima. Za detaljne informacije posjetite www.haier-klima.com.



Model		4U7S2SR5FA	4U85S2SR5FA	5U90S2SS5FA	5U105S2SS5FA
Maksimalan broj unutarnjih jedinica		4	4	5	5
Kapacitet - hlađenje	kW	7.6(2.4-8.7)	8.5(3.2-9.5)	9.0(3.2-11.0)	10(3.2-11.0)
Kapacitet - grijanje	kW	8.6(3.1-10.0)	9.3(4.4-10.5)	10.4(4.4- 11.5)	10.5(4.4- 11.5)
SEER / SCOP		7.0/4.2	7.0/4.2	7.0/4.2	7.0/4.2
Energetska klasa (grijanje / hlađenje)		A++/A+	A++/A+	A++/A+	A++/A+
Napajanje	Ph/V/Hz	1/220-240/50/60	1/220-240/50/60	1/220-240/50/60	1/220-240/50/60
Protok zraka (H/M/L)	m ³ /h	≈4000	≈4000	4200	4200
Razina buke - zvučna snaga H/M/L	db(A)	68	68	70	70
Razina zvučnog tlaka H/M/L	db(A)	55	55	55	55
Vanjske dimenzije W/D/H	mm	890/340/700	890/340/700	920/372/760	920/372/760
Neto / Bruto težina	kg	61/70	61/70	66/77	66/70
Radna tvar		R32	R32	R32	R32
Promjer cijevi tekućinski	mm	4×6.35	4×6.35	5×6.35	5×6.35
Promjer cijevi plinski	mm	3×9.52+1×12.7	3×9.52+1×12.7	3×9.52+2×12.7	3×9.52+2×12.7
Maksimalna duljina cjevovoda	m	70	70	80	80
Maksimalna duljina cjevovoda bez nadopune	m	40	40	40	40
Nadopuna po dodatnom metru	g/m	20	20	20	20
Maksimalna visinska razlika	m	15	15	15	15
Temperaturni raspon rada - hlađenje	°C	-10-46	-10-46	-10-46	-10-46
Temperaturni raspon rada - grijanje	°C	-15-24	-15-24	-15-24	-15-24
Razmak između nogica	mm	630	630	/	660

						4 unutarnje jedinice										5 unutarnjih jedinica					
12	12	12	12	12	18	9	9	9	9	9	9	9	9	9	9	12	9	9	9	9	9
12	12	12	18	18	18	9	9	9	9	9	9	12	12	12	12	12	9	9	9	9	9
12	18	24	18	24	18	9	9	9	9	12	12	12	12	12	12	9	9	9	9	9	
-	-	-	-	-	-	9	12	18	24	12	18	12	18	24	12	9	9	9	12	12	
-	-	-	-	-	-	-	-	-	-	-	-	-	-	-	-	9	12	18	12	18	
*	*					*	*			*											
*	*	*	*			*	*	*		*	*	*			*						
*	*	*	*	*	*	*	*	*	*	*	*	*	*	*	*	*	*	*	*	*	
*	*	*	*	*	*	*	*	*	*	*	*	*	*	*	*	*	*	*	*	*	
*	*	*	*	*	*	*	*	*	*	*	*	*	*	*	*	*	*	*	*	*	

Haier

KOMERCIJALNA SERIJA KLIMA UREĐAJA







KOMPAKTNI KAZETNI MODEL

Elegantan izgled unutarnjih jedinica

Dimenzije unutarnjih jedinica 620 x 620 mm prilagođene su standardnim dimenzijama dekorativnih stropnih panel - ploča. Dizajn unutarnjih jedinica poboljšan je sa spiralnim rešetkama.

UVC sterilizacija

Ugrađeno UV LED svjetlo sterilizira zrak koji cirkulira klima uređajem. Učinkovito eliminira viruse i bakterije pri čemu isporučuje zdrav zrak u prostoriju.



Kompaktni kazetni model



Kompaktni dizajn
620x620 mm



Individualna
kontrola klapni



Wi-Fi



UVC sterilizacija



Antibakterijski
filter



ABS materijal
panela



Jednostavna
instalacija i
održavanje



KAZETNI MODEL	Unutarnja	AB35S2SC2FA (H)	AB50S2SC2FA (H)
	Vanjska	1U35S2SM1FA-2	1U50S2SJ2FA-2
Kapacitet - hlađenja	kW	3.5 (0.9-4.5)	5.0 (1.8-5.8)
Kapacitet - grijanje	kW	4.0 (1-4.8)	5.5 (2-6.5)
SEER/SCOP		6.1/3.8	6.1/4.0
Energetska klasa		A++/A	A++/A+
Unutarnja jedinica			
Napajanje	Ph/V/Hz	1/220~240/50/60	1/220~240/50/60
Protok zraka H/M/L	m³/h	620/520/450	700/620/500
Razina buke - zvučna snaga H/M/L	dB(A)	52	55
Razina zvučnog tlaka H/M/L	dB(A)	36/33/30	42/37/35/32
Vanjske dimenzije Š/D/V	mm	570/570/260	570/570/260
Dimenzije sa ambalažom Š/D/V	mm	718/680/380	718/680/380
Neto / Bruto težina	kg	18.5/22	19/22
Daljinski	Opcija - bežični	YR-HRS01	YR-HRS01
	Opcija - žičani	HW-SA201ABK	HW-SA201ABK
Model panela		PB-620 KB (H) (standard)	PB-620 KB (H) (standard)
Vanjske dimenzije Š/D/V	mm	620/620/60	620/620/60
Dimenzije sa ambalažom Š/D/V	mm	660/660/115	660/660/115
Neto / Bruto težina	kg	2.8/4.5	2.8/4.5
Vanjska jedinica			
Napajanje	Ph/V/Hz	1/220-240/50	1/220-240/50
Protok zraka H/M/L	m³/h	2000	3000
Razina buke - zvučna snaga H/M/L	dB(A)	61	63
Razina zvučnog tlaka H/M/L	dB(A)	48	51
Vanjske dimenzije Š/D/V	mm	800/280/553	820/306/642
Dimenzije sa ambalažom Š/D/V	mm	902/375/614	940/390/697
Neto / bruto težina	kg	30/32.9	37.8/40.5
Radna tvar		R32	R32
Promjer cijevi tekućinski	mm	6.35	6.35
Promjer cijevi plinski	mm	9.52	12.7
Maksimalna duljina cjevovoda	m	20	25
Maksimalna visinska razlika	m	10	15
Temperaturni raspon rada - hlađenje	°C	-20~43	-20~43
Temperaturni raspon rada - grijanje	°C	-20~24	-20~24



360° KAZETNI MODEL



360° ispuh zraka uz moderan dizajn

Haier kazetne unutarnje jedinice ugrađuju se u spuštene stropove te se prilagođavaju svakom prostoru. Konstrukcija klapni dizajnirana je na način da klimatizirani zrak dospje u svaki dio prostorije.

UVC sterilizacija (opcija)

Ugrađeno UV LED svjetlo sterilizira zrak koji cirkulira klima uređajem. Učinkovito eliminira viruse i bakterije pri čemu isporučuje zdrav zrak u prostoriju.



360° kazetni model



360° ispuh zraka



Individualna kontrola klapni



Wi-Fi



UVC sterilizacija (opcija)



Antibakterijski filter (opcija)



Jednostavna instalacija i održavanje



Soft Breeze tehnologija



KAZETNI MODEL	Unutarnja	AB71S2SR1FA(H)	AB105S2SR1FA(H)	AB125S2SR1FA(H)	AB140S2SR1FA(H)	AB160S2SR1FA(H)
	Vanjska	1U71S2SR3FA	1U105S2SQ1FA	1U125S2SN3FB	1U140S2SN2FA	1U160S2SP1FB
Kapacitet - hlađenja	kW	7.1 (2.0-8.2)	9.5 (2.5-10.0)	12.4 (3.0-13.0)	13.4 (3.5-14.0)	15.00 (4.50-16.00)
Kapacitet - grijanje	kW	7.9 (2.5-8.5)	10.5 (3.0-12.5)	13.5 (4.0-15.5)	15.0 (4.0-15.5)	16.00 (5.00-17.00)
SEER/SCOP		6.1/4.0	6.2/4.05	6.1/4.0	5.62/4.0	5.96/3.99
Energetska klasa		A++/A+	A++/A+	A++/A+	A+/A+	A+/A
Unutarnja jedinica						
Napajanje	Ph/V/Hz	1/220~240/50/60	1/220~240/50/60	1/220~240/50/60	1/220~240/50/60	1/220~240/50/60
Protok zraka H/M/L	m³/h	1260/1100/900	1920/1750/1550	1950/1650/1480	1950/1650/1480	2050/1950/1650
Razina buke - zvučna snaga H/M/L	dB(A)	57	62	64	64	65
Razina zvučnog tlaka H/M/L	dB(A)	42/40/38	45/42/38	47/44/38	47/44/38/34	48/44/38
Vanjske dimenzije Š/D/V	mm	840/840/204	840/840/246	840/840/288	840/840/288	840/840/288
Dimenzije sa ambalažom Š/D/V	mm	978/978/269	978/978/269	978/978/353	978/978/353	978/978/353
Neto / Bruto težina	kg	23/28	24/31	27/33	27/33	27/33
Daljinski	Opcija - bežični	YR-HRS01	YR-HRS01	YR-HRS01	YR-HRS01	YR-HRS01
	Opcija - žičani	HW-SA201ABK	HW-SA201ABK	HW-SA201ABK	HW-SA201ABK	HW-SA201ABK
Model panela		PB-950QB(H) (standard)	PB-950QB(H) (standard)	PB-950QB(H) (standard)	PB-950QB(H) (standard)	PB-950QB(H) (standard)
Vanjske dimenzije Š/D/V	mm	950/950/50	950/950/50	950/950/50	950/950/50	950/950/50
Dimenzije sa ambalažom Š/D/V	mm	1013/1035/125	1013/1035/125	1013/1035/125	1013/1035/125	1013/1035/125
Neto / Bruto težina	kg	5.5/8.5	5.5/8.5	5.5/8.5	5.5/8.5	5.5/8.5
Vanjska jedinica						
Napajanje	Ph/V/Hz	1/220~240/50/60	1/220~240/50/60	3/380~415/ 50/60	1/220~240/50/60	3/380~415/ 50/60
Protok zraka H/M/L	m³/h	3000	3500	4200	4500	7400
Razina buke - zvučna snaga H/M/L	dB(A)	68	68	72	74	72
Razina zvučnog tlaka H/M/L	dB(A)	54	54	58	58	58
Vanjske dimenzije Š/D/V	mm	890/340/700	950/370/815	950/370/965	950/370/965	950/370/1350
Dimenzije sa ambalažom Š/D/V	mm	985/430/720	1085/465/850	1050/485/1130	1050/485/1130	1050/485/1500
Neto / bruto težina	kg	37/42	56/60	63/67	68/78	101/116
Radna tvar		R32	R32	R32	R32	R32
Promjer cijevi tekućinski	mm	9.52	9.52	9.52	9.52	9.52
Promjer cijevi plinski	mm	15.88	15.88	15.88	15.88	19.05
Maksimalna duljina cjevovoda	m	50	50	50	70	70
Maksimalna visinska razlika	m	30	30	30	30	30
Temperaturni raspon rada - hlađenje	°C	-20~46	-20~46	-20~46	-20~46	-20~46
Temperaturni raspon rada - grijanje	°C	-20~24	-20~24	-20~24	-20~24	-20~24



SLIM KANALNI MODEL

Moderan dizajn

Haier slim kanalne jedinice dizajnirane su kako bi se prilagodile u prostore s ograničenim opcijama za klimatizaciju. Omogućen je 3D protok zraka kako bi se klimatizirao svaki dio prostorije.

Antibakterijski filter

Antibakterijski filter sadrži ione srebra i antibakterijske organske tvari na komponentama jedinice kroz koje prolazi zrak. Filter eliminira bakterije poput *Escherichia Coli* i *Staphylococcus aureus* s učinkovitošću do 99,99%.



Slim kanalni model



UVC
sterilizacija



Antibakterijski
filter



SLIM dizajn
visina 185 mm



Wi-Fi



3D ispuh
zraka



Jednostavna
instalacija i
održavanje



SLIM KANALNI MODEL	Unutarnja	AD35S2SS1FA (H)	AD50S2SS1FA (H)	AD71S2SS1FA (H)
	Vanjska	1U35S2SM1FA	1U50S2SJ2FA	1U71S2SR2FA
Kapacitet - hlađenja	kW	3.5 (0.9-4.5)	5.0 (1.8-6)	7.1 (2-7.6)
Kapacitet - grijanje	kW	4.0 (1-4.8)	5.5 (2-6.2)	7.5 (3.0-8.30)
SEER/SCOP		6.1/3.8	6.1/4.0	6.1/3.8
Energetska klasa		A++/A	A++/A+	A++/A
Unutarnja jedinica				
Napajanje	Ph/V/Hz	1/220~240/50/60	1/220~240/50/60	1/220~240/50/60
Protok zraka H/M/L	m³/h	600/480/420	900/750/600	1000/850/750
Razina buke - zvučna snaga H/M/L	dB(A)	53	54	57
Razina zvučnog tlaka H/M/L	dB(A)	33/28/25	36/34/32	46/44/42
Model panela		P1B-890IA/D	P1B-1210IA/D	P1B-1210IA/D
Vanjske dimenzije Š/D/V	mm	850/420/185	1170/420/185	1170/420/185
Dimenzije sa ambalažom Š/D/V	mm	1045/530/260	1365/530/260	1365/530/260
Neto / Bruto težina	kg	16/21	22/28	25.2/28.4
Daljinski	Opcija - bežični	YR-HRS01	YR-HRS01	YR-HRS01
	Opcija - žičani	HW-SA201ABK	HW-SA201ABK	HW-SA201ABK
Vanjska jedinica				
Napajanje	Ph/V/Hz	1/230/50	1/230/50	1/220~240/50/60
Protok zraka H/M/L	m³/h	2000	2500	3000
Razina buke - zvučna snaga H/M/L	dB(A)	61	63	67
Razina zvučnog tlaka H/M/L	dB(A)	48	51	54
Vanjske dimenzije Š/D/V	mm	800/275/553	820/338/614	890/340/700
Dimenzije sa ambalažom Š/D/V	mm	954/409/625	993/413/685	1046/460/780
Neto / bruto težina	kg	31.5/34	37.8/41.5	45/50
Radna tvar		R32	R32	R32
Promjer cijevi tekućinski	mm	6.35	6.35	9.52
Promjer cijevi plinski	mm	9.52	12.7	15.88
Maksimalna duljina cjevovoda	m	15	25	50
Maksimalna visinska razlika	m	10	15	30
Temperaturni raspon rada - hlađenje	°C	-10~43	-10~46	-20~46
Temperaturni raspon rada - grijanje	°C	-15~24	-15~24	-20~24



KANALNI MODEL SREDNJI ESP

Fleksibilna ugradnja i vrhunska sterilizacija zraka

Diskretno skrivena u strop, kanalna jedinica s raspoloživim statičkim tlakom 150 Pa olakšava korištenje jedinice zahvaljujući fleksibilnim cijevima raznih duljina.

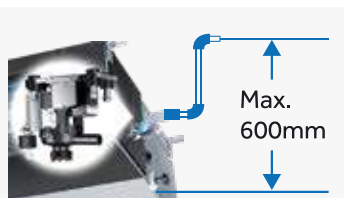

UVC sterilizacija

Ugrađeno UV LED svjetlo sterilizira zrak koji cirkulira klima uređajem. Učinkovito eliminira viruse i bakterije pri čemu isporučuje zdrav zrak u prostoriju.



Kanalni model srednji ESP



UVC
sterilizacija



Antibakterijski
filter



Wi-Fi



Ugrađena
pumpa
za odvod
kondenzata



SLIM dizajn
visina 248 mm



Pretvorba
vanjskog
statičkog tlaka
do 10 stupnjeva



Jednostavna
instalacija i
održavanje



KANALNI MODEL	Unutarnja	AD35S2SM9FA(H)	AD50S2SM9FA(H)	AD71S2SM9FA(H)	AD105S2SM9FA(H)
	Vanjska	1U35S2SM1FA	1U50S2SJ2FA	1U71S2SR3FA	1U105S2SQ1FA
Kapacitet - hlađenja	kW	3.50 (0.9-4.5)	5.0 (1.8-6)	7.1 (2.0-8.2)	9.50 (2.50-10.00)
Kapacitet - grijanje	kW	4.0 (1-4.8)	6.0 (2-6.2)	7.6 (2.5-8.5)	10.5 (3.0-12.50)
SEER/SCOP		6.1/4.0	6.1/4.0	6.2/4.2	6.2/4.0
Energetska klasa		A++/A+	A++/A+	A++/A+	A++/A+
Unutarnja jedinica					
Napajanje	Ph/V/Hz	1/220~240/50/60	1/220~240/50/60	1/220~240/50/60	1/220~240/50/60
Protok zraka H/M/L	m³/h	840/720/600	1020/900/780	1400/1260/1050	1600/1480/1360
Razina buke - zvučna snaga H/M/L	dB(A)	55	56	58	61
Razina zvučnog tlaka H/M/L	dB(A)	41/35/28	43/37/30	44/41/39	47/44/40
Vanjske dimenzije Š/D/V	mm	700/700/248	1100/700/248	1100/700/248	1100/700/248
Neto / Bruto težina	kg	26/30	31/35	31/35	38/42
Daljinski	Opcija - bežični	YR-HRS01	YR-HRS01	YR-HRS01	YR-HRS01
	Opcija - žičani	HW-SA201ABK	HW-SA201ABK	HW-SA201ABK	HW-SA201ABK
Vanjska jedinica					
Napajanje	Ph/V/Hz	1/230/50	1/230/50	1/220~240/50/60	1/220~240/50/60
Protok zraka H/M/L	m³/h	2000	2500	3000	3500
Razina buke - zvučna snaga H/M/L	dB(A)	61	63	68	68
Razina zvučnog tlaka H/M/L	dB(A)	48	51	54	54
Vanjske dimenzije Š/D/V	mm	800/275/553	820/338/614	890/340/700	950/370/815
Dimenzije sa ambalažom Š/D/V	mm	954/409/625	993/413/685	985/430/720	1085/465/850
Neto / bruto težina	kg	31.5/34	37.8/41.5	37/42	56/60
Radna tvar		R32	R32	R32	R32
Promjer cijevi tekućinski	mm	6.35	6.35	9.52	9.52
Promjer cijevi plinski	mm	9.52	12.7	15.88	15.88
Maksimalna duljina cjevovoda	m	15	25	50	50
Maksimalna visinska razlika	m	10	15	30	30
Temperaturni raspon rada - hlađenje	°C	-10~43	-10~46	-20~46	-20~46
Temperaturni raspon rada - grijanje	°C	-15~24	-15~24	-20~24	-20~24



KANALNI MODEL VISOKI ESP

Nevidljiva jedinica

Haier kanalne jedinice dizajnirane su kako bi se prilagodile prostorima s ograničenim opcijama za klimatizaciju.

Visoki protok zraka

Novi DC motor i produženi promjer ventilatora osiguravaju 2880 m³/h (800l/s), što je 44% više od srednjetačne kanalske jedinice.

Visoka učinkovitost

Istosmjerni motor ventilatora i izmjenjivač topline osigurava EER >3,4 za sve kombinacije visokotlačnih kanala.

Kapacitet	Protok zraka srednji tlak (m ³ /h)	Protok zraka visoki tlak (m ³ /h)	Poboljšani učinak
10.0kW	2000	2880	44%
12.5kW	2250	3250	44%
14.0kW	2500	3600	44%

Kanalni model visoki ESP



Ugrađena pumpa za odvod kondenzata



Kompaktni dizajn - visina 425 mm



Super tihi rad



Jednostavna instalacija i održavanje

RASPOLOŽIVI
STATIČKI
TLAK
do 210 Pa



(omogućuje fleksibilnost prilikom projektiranja)



KANALNI MODEL	Unutarnja	ADH125H1ERG	ADH140H1ERG	ADH160H1ERG
	Vanjska	1U125S2SN2FB	1U140S2SN1FB	1UH160P1ERG
Kapacitet - hlađenja	kW	12.4(3.0-13.0)	13.4(3.5-14.0)	15.00(4.50-16.00)
Kapacitet - grijanje	kW	12.8(3.5-13.5)	15.0(4.0-15.5)	16.00(5.00-17.00)
SEER/SCOP		5.9/3.97	5.98/3.97	5.60/4.00
Energetska klasa		A+/A	A+/A	A+/A +
Unutarnja jedinica				
Napajanje	Ph/V/Hz	1/220~240/50/60	1/220~240/50/60	1/220~240/50/60
Protok zraka H/M/L	m³/h	3250/2750/2250/1750	3600/3100/2600/2100	4000/3400/2800
Razina buke - zvučna snaga H/M/L	dB(A)	64	65	67
Razina zvučnog tlaka H/M/L	dB(A)	47/44/42/39	49/46/43/40	50/47/45/42
Vanjske dimenzije Š/D/V	mm	1350/490/425	1350/490/425	1350/490/425
Neto / Bruto težina	kg	61/72	61/72	61/72
Daljinski	Opcija - bežični	YR-HRS01	YR-HRS01	YR-HRS01
	Opcija - žičani	HW-SA201ABK	HW-SA201ABK	HW-SA201ABK
Vanjska jedinica				
Napajanje	Ph/V/Hz	3/380-415/ 50/60	3/380-415/ 50/60	1/220-240/ 50/60
Protok zraka H/M/L	m³/h	4200	4200	7500
Razina buke - zvučna snaga H/M/L	dB(A)	72	72	73
Razina zvučnog tlaka H/M/L	dB(A)	58	58	57
Vanjske dimenzije Š/D/V	mm	950/370/965	950/370/965	1350/950/370
Dimenzije sa ambalažom Š/D/V	mm	1050/485/1130	1050/485/1130	1500/1090/480
Neto / bruto težina	kg	85/90	85/90	105/118
Radna tvar		R32	R32	R410A
Promjer cijevi tekućinski	mm	9.52	9.52	9.52
Promjer cijevi plinski	mm	15.88	15.88	15.88
Maksimalna duljina cjevovoda	m	50	70	75
Maksimalna visinska razlika	m	30	30	30
Temperaturni raspon rada - hlađenje	°C	-20~46	-20~46	-15~52
Temperaturni raspon rada - grijanje	°C	-20~24	-20~24	-20~24



PODNOSTROPNI MODEL

Moderan dizajn

Haier podno stropni model prilagođava se svakom prostoru s vrhunskim ispuhom zraka. Zrak se ravnomjerno raspoređuje u svakom kutu prostorije, kako bi se osigurala maksimalna udobnost. Jedinica se može postaviti na strop na visini od 4,2 m.

Antibakterijski filter

Antibakterijski filter sadrži ione srebra koje ima antiseptička svojstva za uništavanje širokog spektra bakterija s učinkovitošću do 99,99%.



Podnostropni model



KOMPAKTAN DIZAJN

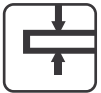

Prilagođava se svakom prostoru npr. uskim ili kutnim prostorima



UVC sterilizacija



Antibakterijski filter



Wi-Fi



3D ispuh zraka



Super tihi rad 34 dB (A)



Jednostavna instalacija i održavanje



PODNOSTROPNI MODEL	Unutarnja	AC35S2SG2FA(H)	AC50S2SG2FA(H)	AC71S2SG2FA(H)	AC105S2SH2FA(H)	AC125S2SK2FA(H)	AC140S2SK2FA(H)	AC160S2SK2FA(H)
	Vanjska	1U35S2SM1FA-2	1U50S2SJ2FA-2	1U71S2SR3FA	1U105S2SQ1FA	1U125S2SN3FB	1U140S2SN2FB	1U160S2SP1FB
Kapacitet - hlađenja	kW	3.5 (1.0-4.3)	5.0 (1.4-5.7)	7.1 (2.0-8.2)	9.5 (2.5-10.0)	12.4 (3.0-13.0)	13.4 (3.5-14.0)	16.00 (4.50-16.50)
Kapacitet - grijanje	kW	4.0 (1.0-5.3)	5.8 (1.4-6.0)	7.8 (2.5-8.5)	10.5 (3.0-12.5)	13.5 (4.0-15.5)	15.0 (4.0-15.5)	17.00 (5.00-18.00)
SEER/SCOP		8.5/4.47	7.31/4.1	6.2/4.0	6.2/4.0	6.1/4.0	5.97/4.0	6.1/4.06
Energetska klasa		A+++/A+	A++/A+	A++/A+	A++/A+	A++/A+	A+/A+	A++/A+
Unutarnja jedinica								
Napajanje	Ph/V/Hz	1/220~240/50/60	1/220~240/50/60	1/220~240/50/60	1/220~240/50/60	1/220~230/50/60	1/220~240/50/60	1/220~240/50/60
Protok zraka H/M/L	m³/h	750/620/500	880/750/650	1250/1128/930	1600/1400/1280	2050/1900/1600	2150/1980/1800	2250/2000/1850
Razina buke - zvučna snaga H/M/L	dB(A)	53	57	61	63	64	66	67
Razina zvučnog tlaka H/M/L	dB(A)	39/36/33	44/41/38	43/40/38	43/43/41	47/43/41	48/46/43	48/46/43
Vanjske dimenzije Š/D/V	mm	1000/230/680	1000/230/680	1325/230/680	1325/230/680	1650/230/680	1650/230/680	1650/230/680
Neto / Bruto težina	kg	26/32	26/32	34/42	34/42	43/51	43/51	43/51
Daljinski	Opcija - bežični	YR-HRS01	YR-HRS01	YR-HRS01	YR-HRS01	YR-HRS01	YR-HRS01	YR-HRS01
	Opcija - žičani	HW-SA201ABK	HW-SA201ABK	HW-SA201ABK	HW-SA201ABK	HW-SA201ABK	HW-SA201ABK	HW-SA201ABK
Vanjska jedinica								
Napajanje	Ph/V/Hz	1/220~240/50/60	1/220~240/50/60	1/220~240/50/60	1/220~240/50/60	3/380~415/50/60	3/380~415/50/60	3/380~415/50/60
Protok zraka H/M/L	m³/h	2000	3000	3000	3500	4200	4500	7400
Razina buke - zvučna snaga H/M/L	dB(A)	61	63	68	68	72	74	72
Razina zvučnog tlaka H/M/L	dB(A)	48	50	54	54	58	58	58
Vanjske dimenzije Š/D/V	mm	800/280/553	820/306/642	890/340/700	950/370/815	950/370/965	950/370/965	950/370/1350
Dimenzije sa ambalažom Š/D/V	mm	902/375/614	940/390/697	985/430/720	1085/465/850	1050/485/1130	1050/485/1130	1050/485/1500
Neto / bruto težina	kg	30/32.9	37.8/40.5	37/42	56/60	63/73	68/78	101/116
Radna tvar		R32	R32	R32	R32	R32	R32	R32
Promjer cijevi tekućinski	mm	6.35	6.35	9.52	9.52	9.52	9.52	9.52
Promjer cijevi plinski	mm	9.52	12.7	15.88	15.88	15.88	15.88	19.05
Maksimalna duljina cjevovoda	m	20	25	50	50	50	70	70
Maksimalna visinska razlika	m	10	15	30	30	30	30	30
Temperaturni raspon rada - hlađenje	°C	-20~43	-20~43	-20~46	-20~46	-20~46	-20~46	-20~46
Temperaturni raspon rada - grijanje	°C	-20~24	-20~24	-20~24	-20~24	-20~24	-20~24	-20~24



PODNI INVERTER MODEL

Podni model s dvostrukim ispuhom zraka

Haier podni model prilagođava se svakom prostoru s vrhunskim ispuhom zraka. Zrak se ravnomjerno raspoređuje u svakom kutu prostorije, kako bi se osigurala maksimalna udobnost.

56°C sterilizacija

Ubija bakterije i viruse zagrijavanjem isparivača na visokih 56°C tijekom 30 minuta.

Antibakterijski filter

Antibakterijski filter sadrži ione srebra koje ima antiseptička svojstva za uništavanje širokog spektra bakterija s učinkovitošću do 99,99%.



Podni inverter model



Super tihi rad
21 dB (A)



Wi-Fi



Dupli ispuh
(gornja i
donja strana)



Jednostavna
instalacija i
održavanje
-podna i zidna
ugradnja



56°C
sterilizacija



Antibakterijski
filter

PODNA JEDINICA		Unutar.		AF25S2SD1FA(D)	AF35S2SD1FA(D)	AF42S2SD1FA(D)
		Vanjska		1U25S2SM1FA-2	1U35S2SM1FA-2	1U42S2SM1FA
HLADENJE	Kapacitet	Nominalno (Min.-Max.)	kW	2.5 (0.8-3.2)	3.4 (1.0-4.0)	4.20 (1.40-4.50)
	Energetska efikasnost / razred	SEER koeficijent	Ušteda energije	8.0 (A++)	7.5 (A++)	7.00 (A++)
	Snaga električnog priključka	Nominalno (Min.-Max.)	kW	0.65 (0.2-1.3)	0.94 (0.3-1.5)	1.30 (0.50-1.60)
	Temperaturni raspon rada (Hlađenje)	Min. - Max.	°C	-20-43°C	-20-43°C	-20-43°C
GRIJANJE	Kapacitet	Nominalno (Min.-Max.)	kW	3.00 (0.80-3.80)	3.5 (1.1-4.5)	4.70 (1.40-5.00)
	Energetska efikasnost / razred	SCOP koeficijent	Ušteda energije	4.2 (A+)	4.2 (A+)	4.0 (A+)
	Snaga električnog priključka - grijanje	Nominalno (Min.-Max.)	kW	0.80 (0.30-1.6)	0.94 (0.5-1.6)	1.50 (0.60-1.90)
	Temperaturni raspon rada (Grijanje)	Min. - Max.	°C	-20-24°C	-20-24°C	-20-24°C
Napajanje		Ph/V/Hz		1/220-240/50/60	1/220-240/50/60	1/220-240/50/60
Napajanje (pozicija)				Vanjska (3x1.5)	Vanjska (3x1.5)	Vanjska (3x1.5)
Unutarnja jedinica						
Neto dimenzije		Š/D/V	mm	700/210/600	700/210/600	700/210/600
Dimenzije sa ambalažom		Š/D/V	mm	783/303/695	783/303/695	783/303/695
Neto / bruto težina			kg	16.5/18.5	16.5/18.5	16.5/18.5
Daljinski		Opcija - bežični		YR-HRS01	YR-HRS01	YR-HRS01
Protok zraka		Max.	m³/h	400/350/300	450/400/350	530/480/430
Ovlaživanje			lit/h	1.2	1.6	1.8
Razina buke - zvučni tlak		(H/Mid/Lo/So)	db(A)	40/32/25/20	42/34/26/21	46/37/33
Vanjska jedinica						
Neto dimenzije		Š/D/V	mm	800/280/553	800/280/553	800/280/553
Dimenzije sa ambalažom		Š/D/V	mm	902/375/614	902/375/614	902/375/614
Neto / bruto težina			kg	27.6/30.4	30/32.9	31.5/34
Protok zraka		Max.	m³/h	1900	2000	2100
Razina buke - zvučni tlak		Hi/Lo	db(A)	47	48	50
Vrsta radne tvari		R32		R32	R32	R32
Količina radne tvari		R32	g	630	780	940
Dodatna količina radne tvari			g/m	20	20	20
Promjeri cijevi	Tekućinski		mm	6.35	6.35	6.35
	Plinski		mm	9.52	9.52	9.52
	Max. dozvoljena duljina cjevovoda		m	20	20	20
	Max. duljina cjevovoda bez nadoknade		m	7	7	7
	Nadoknada po dodatnom metru		g/m	20	20	20
	Max. visinska razlika		m	10	10	10
Međuveza			mm²	4x1.5	4x1.5	4x1.5
Razmak nogica			mm	510	510	510

Haier

MRV SISTEMI





MRV5-H
DC INVERTER

Haier

Neprekidno grijanje, neprekidna udobnost



Kompresor EVI

poboljšana energetska učinkovitost za 30%

Neprekidno grijanje

inteligentna tehnika odležavanja

Dvostupanjska tehnika pothlađivanja

poboljšani rashladni i toplinski učini

Supervodljiva tehnika hlađenja radne tvari

osiguran pouzdan rad elemenata elektroničke regulacije



MRV sustavi

unutarnje jedinice



ZIDNI MODELI	Kapacitet (kW)		Protok zraka (m ³ /h)	Razina buke dB(A)	Neto dimenzija ŠxDxV (mm)	Neto/Bruto težina (kg)	Promjeri cijevi mm (")		Daljinski upravljač (S - standard, O - opcija)	
	Hlađenje	Grijanje					Tekućinski vod (tlačni)	Plinski vod (usisni)	Žičani	Infracrveni
AS052MNERAB	1,5	1,7	500/430/370	49/46/41	855x208x280	9,9/12	6,35	9,52	O	O
AS072MNERAB	2,2	2,5	550/480/420	50/47/42	855x208x280	9,9/12	6,35	9,52	O	O
AS092MNERAB	2,8	3,2	600/530/470	52/48/44	855x208x280	9,9/12	6,35	9,52	O	O
AS122MNERAB	3,6	4,0	630/560/500	54/51/50	855x208x280	9,9/12	6,35	12,7	O	O
AS162MNERA	4,5	5,0	800/720/650	56/53/51	1115x243x336	15,8/18,9	6,35	12,7	O	O
AS182MNERA	5,6	6,3	920/800/720	57/54/52	1115x243x336	15,8/18,9	6,35	12,7	O	O
AS242MNERA	7,1	8,0	1010/920/800	58/56/54	1115x243x336	15,8/18,9	9,52	15,88	O	O
AS282MNERA	8,0	9,0	1500/1400/1300	60/57/53	1316x270x365	21,8/26,3	9,52	15,88	O	O
AS302MNERA	9,0	10,0	1600/1500/1400	61/58/54	1316x270x365	21,8/26,3	9,52	15,88	O	O

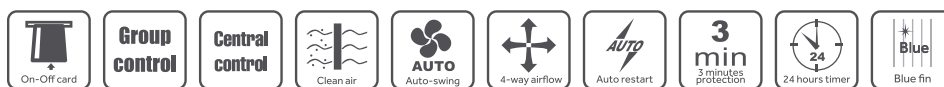

4-SMJERNI KAZETNI MODELI	Kapacitet (kW)		Protok zraka (m ³ /h)	Razina buke dB(A)	Neto dimenzija ŠxDxV (mm)	Neto/Bruto težina (kg)	Promjeri cijevi mm (")		Daljinski upravljač (S - standard, O - opcija)		Panel
	Hlađenje	Grijanje					Tekućinski vod (tlačni)	Plinski vod (usisni)	Žičani	Infracrveni	
AB052MCERA (M)	1,5	1,7	650/540/430	46/44/43	570x570x260	16/19	6,35	9,52	O	O	PB-620KB (H)
AB072MCERA(M)	2,2	2,5	700/590/480	46/44/43	570x570x260	16/19	6,35	9,52	O	O	PB-620KB (H)
AB092MCERA (M)	2,8	3,2	700/590/480	46/44/43	570x570x260	16/19	6,35	9,52	O	O	PB-620KB (H)
AB122MCERA (M)	3,6	4,0	700/590/480	47/44/43	570x570x260	19/22	6,35	12,7	O	O	PB-620KB (H)
AB162MCERA (M)	4,5	5,0	700/590/480	47/44/43	570x570x260	19/22	6,35	12,7	O	O	PB-620KB (H)
AB182MCERA (M)	5,6	6,3	700/590/480	48/46/44	570x570x260	19/22	6,35	12,7	O	O	PB-620KB (H)

4-SMJERNI KAZETNI MODELI	Kapacitet (kW)		Protok zraka (m ³ /h)	Razina zvučnog tlaka db(A) H/M/L	Neto dimenzija ŠxDxV (mm)	Neto/Bruto težina (kg)	Promjeri cijevi mm (")		Daljinski upravljač (S - standard, O - opcija)		Panel
	Hlađenje	Grijanje					Tekućinski vod (tlačni)	Plinski vod (usisni)	Žičani	Infracrveni	
AB072MRERA	2,2	2,5	1000/810/620	30/27/25	840x840x183	25/28	6,35	9,52	O	O	PB-950KB (H)
AB092MRERA	2,8	3,2	1000/810/620	30/27/25	840x840x183	25/28	6,35	9,52	O	O	PB-950KB (H)
AB122MRERA	3,6	4,0	1000/810/620	30/27/25	840x840x183	25/28	6,35	12,7	O	O	PB-950KB (H)
AB162MRERA	4,5	5,0	1000/810/620	32/29/27	840x840x183	25/28	6,35	12,7	O	O	PB-950KB (H)
AB182MRERA	5,6	6,3	1000/810/620	33/30/29	840x840x183	25/28	6,35	12,7	O	O	PB-950KB (H)
AB242MRERA	7,1	8,0	1380/1190/1000	35/34/31	840x840x204	27/30	9,52	15,88	O	O	PB-950KB (H)
AB282MRERA	8,0	9,0	1380/1190/1000	37/35/31	840x840x204	27/30	9,52	15,88	O	O	PB-950KB (H)
AB302MRERA	9,0	10,0	2050/1860/1670	37/35/31	840x840x246	31/36	9,52	15,88	O	O	PB-950KB (H)
AB382MRERA	11,2	12,5	2050/1860/1670	37/35/31	840x840x246	31/36	9,52	15,88	O	O	PB-950KB (H)
AB482MRERA	14,0	16,0	2100/1910/1720	44/40/36	840x840x288	33/38	9,52	15,88	O	O	PB-950KB (H)
AB602MRERA	16,0	18,0	2100/1910/1720	44/40/36	840x840x288	33/38	9,52	15,88	O	O	PB-950KB (H)

MRV sustavi

unutarnje jedinice



JEDNOSMJERNI KAZETNI MODEL	Kapacitet (kW)		Protok zraka (m³/h)	Razina buke dB(A)	Neto dimenzija ŠxDxV (mm)	Neto/Bruto težina (kg)	Promjeri cijevi mm (")		Daljinski upravljač (S - standard, O - opcija)		Panel
	Hlađenje	Grijanje					Tekućinski vod (tlačni)	Plinski vod (usisni)	Žičani	Infracrveni	
AB052MAERAD	1.5	1.7	540/400/270	52/47/42	850/535/185	19.5/24.5	6.35	9.52	O	O	P1B-1028IB
AB072MAERAD	2.2	2.5	540/400/270	52/47/42	850/535/185	20.5/25.5	6.35	9.52	O	O	P1B-1028IB
AB092MAERAD	2.8	3.2	540/400/270	52/47/42	850/535/185	20.5/25.5	6.35	9.52	O	O	P1B-1028IB
AB122MAERAD	3.6	4.0	650/510/390	54/50/45	850/535/185	20.5/25.5	6.35	12.7	O	O	P1B-1028IB
AB162MAERAD	4.5	5.0	700/530/410	55/50/46	850/535/185	21.5/26.5	6.35	12.7	O	O	P1B-1028IB
AB182MAERAD	5.6	6.3	820/660/510	54/50/46	1170/535/185	26/32	6.35	12.7	O	O	P1B-1348IB
AB242MAERAD	7.1	8.0	870/690/510	56/50/46	1170/535/185	28/34	9.52	15.88	O	O	P1B-1348IB



2-SMJERNI KAZETNI MODEL	Kapacitet (kW)		Protok zraka (m³/h)	Razina buke dB(A)	Neto dimenzija ŠxDxV (mm)	Neto/Bruto težina (kg)	Promjeri cijevi mm (")		Daljinski upravljač (S - standard, O - opcija)		Panel
	Hlađenje	Grijanje					Tekućinski vod (tlačni)	Plinski vod (usisni)	Žičani	Infracrveni	
AB072MBERAD	2.2	2.5	650/550/390	48/49/44	1000/600/290	33/40	6.35	9.52	O	O	P2B-1160IB
AB092MBERAD	2.8	3.2	700/600/410	50/47/45	1000/600/290	33/40	6.35	9.52	O	O	P2B-1160IB
AB122MBERAD	3.6	4.0	730/600/430	51/48/46	1000/600/290	33/40	6.35	12.7	O	O	P2B-1160IB
AB162MBERAD	4.5	5.0	800/650/450	53/50/48	1000/600/290	34/41	6.35	12.7	O	O	P2B-1160IB
AB182MBERAD	5.6	6.3	950/780/500	55/53/50	1000/600/290	34/41	6.35	12.7	O	O	P2B-1160IB
AB242MBERAD	7.1	8.0	1000/850/700	56/54/51	1000/600/290	34/41	9.52	15.88	O	O	P2B-1160IB
AB282MBERAD	8.0	9.0	1100/950/800	57/55/52	1400/600/290	45/54	9.52	15.88	O	O	P2B-1560IB
AB302MBERAD	9.0	10.0	1500/1350/1110	58/55/52	1400/600/290	45/54	9.52	15.88	O	O	P2B-1560IB
AB382MBERAD	11.2	12.5	1700/1450/1200	60/56/52	1400/600/290	45/54	9.52	15.88	O	O	P2B-1560IB
AB482MBERAD	14.0	16.0	1950/1750/1350	62/58/54	1400/600/290	45/54	9.52	15.88	O	O	P2B-1560IB



PODNO STROPNI MODEL	Kapacitet (kW)		Protok zraka (m³/h)	Razina buke dB(A)	Neto dimenzija ŠxDxV (mm)	Neto/Bruto težina (kg)	Promjeri cijevi mm (")		Daljinski upravljač (S - standard, O - opcija)	
	Hlađenje	Grijanje					Tekućinski vod (tlačni)	Plinski vod (usisni)	Žičani	Infracrveni
AC092MDERA	2.8	3.2	820/750/690	52/50/47	1000x230x680	27.9/33.6	6.35	9.52	O	O
AC122MDERA	3.6	4.0	820/750/690	52/50/47	1000x230x680	27.9/33.6	6.35	12.7	O	O
AC162MDERA	4.5	5.0	950/820/690	55/51/48	1000x230x680	27.9/33.6	6.35	12.7	O	O
AC182MDERA	5.6	6.3	950/820/690	55/51/48	1000x230x680	27.9/33.6	6.35	12.7	O	O
AC242MDERA	7.1	8.0	1420/1270/1240	60/58/54	1325x230x680	35.8/42.1	9.52	15.88	O	O
AC282MDERA	8.0	9.0	1570/1420/1240	61/58/54	1325x230x680	35.8/42.1	9.52	15.88	O	O
AC302MDERA	9.0	10.0	1570/1420/1240	61/58/55	1325x230x680	35.8/42.1	9.52	15.88	O	O
AC382MDERA	11.2	12.5	2110/1990/1750	63/60/57	1650x230x680	43.5/50.5	9.52	15.88	O	O
AC482MDERA	14.0	16.0	2110/1990/1750	63/60/57	1650x230x680	43.5/50.5	9.52	15.88	O	O



PODNI MODELI	Kapacitet (kW)		Protok zraka (m ³ /h)	Razina zvučnog tlaka db(A) H/M/L	Neto dimenzija ŠxDxV (mm)	Neto/Bruto težina (kg)	Promjeri cijevi mm (")		Daljinski upravljač (S - standard, O - opcija)	
	Hlađenje	Grijanje					Tekućinski vod (tlačni)	Plinski vod (usisni)	Žičani	Infracrveni
AF052MBERA	1,5	1,7	540/460/390/310/270	45/42/38/33/30	700x210x600	15,2/18,7	6,35	12,7	O	O
AF072MBERA	2,2	2,6	540/460/390/310/270	45/42/38/33/30	700x210x600	15,2/18,7	6,35	12,7	O	O
AF092MBERA	2,8	3,2	540/460/390/310/270	45/42/38/33/30	700x210x600	15,2/18,7	6,35	12,7	O	O
AF122MBERA	3,6	4,0	580/500/420/350/270	47/44/40/36/30	700x210x600	15,2/18,7	6,35	12,7	O	O
AF182MBERA	5,0	5,5	620/540/460/390/270	48/45/42/38/30	700x210x600	15,2/18,7	6,35	12,7	O	O

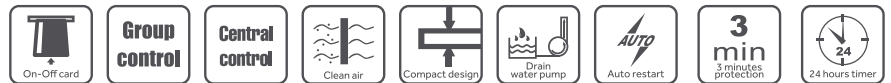

SLIM KANALNI MODELI (0/30 Pa)	Kapacitet (kW)		Protok zraka (m ³ /h)	Razina buke dB(A)	Neto dimenzija ŠxDxV (mm)	Neto/Bruto težina (kg)	Promjeri cijevi mm (")		Daljinski upravljač (S - standard, O - opcija)		Panel (opcija)
	Hlađenje	Grijanje					Tekućinski vod (tlačni)	Plinski vod (usisni)	Žičani	Infracrveni	
AD052MSERA (D)	1,5	1,7	430/370/310	40/37/34	850x420x185	16,5/21,5	6,35	9,52	O	O	P1B-890IA/D
AD072MSERA (D)	2,2	2,5	480/420/360	41/38/35	850x420x185	17,5/22,5	6,35	9,52	O	O	P1B-890IA/D
AD092MSERA (D)	2,8	3,2	480/420/360	41/38/35	850x420x185	17,5/22,5	6,35	9,52	O	O	P1B-890IA/D
AD242MSERA (D)	7,1	8,0	930/850/750	50/47/44	1170x420x185	24/30	9,52	15,88	O	O	P1B-1210IA/D

KANALNI MODELI (0/15/30 Pa)	Kapacitet (kW)		Protok zraka (m ³ /h)	Razina buke dB(A)	Neto dimenzija ŠxDxV (mm)	Neto/Bruto težina (kg)	Promjeri cijevi mm (")		Daljinski upravljač (S - standard, O - opcija)		Panel
	Hlađenje	Grijanje					Tekućinski vod (tlačni)	Plinski vod (usisni)	Žičani	Infracrveni	
AD122MSERA (D)	3,6	4,0	550/430/370	44/42/39	850x420x185	17,5/22,5	6,35	12,7	O	O	P1B-890IA/D
AD162MSERA (D)	4,5	5,0	600/540/460	47/44/41	850x420x185	18,5/23,5	6,35	12,7	O	O	P1B-890IA/D
AD182MSERA (D)	5,6	6,3	800/690/580	50/47/44	1170x420x185	22,2/28,2	6,35	12,7	O	O	P1B-1210IA/D



KANALNI MODELI (20/200 Pa)	Kapacitet (kW)		Protok zraka (m ³ /h)	Razina buke dB(A)	Neto dimenzija ŠxDxV (mm)	Neto/Bruto težina (kg)	Promjeri cijevi mm (")		Daljinski upravljač (S - standard, O - opcija)	
	Hlađenje	Grijanje					Tekućinski vod (tlačni)	Plinski vod (usisni)	Žičani	Infracrveni
AD052MJERAD	1,5	1,7	515/440/390	41/39/37	700/700/248	25/30,7	6,35	9,52	O	O
AD072MJERAD	2,2	2,5	545/470/390	42/40/37	700/700/248	25/30,7	6,35	9,52	O	O
AD092MJERAD	2,8	3,2	545/470/390	42/40/37	700/700/248	25/30,7	6,35	9,52	O	O
AD122MJERAD	3,6	4,0	570/495/420	43/41/39	700/700/248	25/30,7	6,35	12,7	O	O
AD162MJERAD	4,5	5,0	700/625/550	44/42/40	700/700/248	26,2/31,9	6,35	12,7	O	O
AD182MJERAD	5,6	6,3	915/765/640	45/43/41	1100/700/248	34/40,5	6,35	12,7	O	O
AD242MJERAD	7,1	8,0	1275/1050/875	46/43/41	1100/700/248	34/40,5	9,52	15,88	O	O
AD282MJERAD	8,0	9,0	1275/1050/875	47/45/42	1100/700/248	34/40,5	9,52	15,88	O	O
AD302MJERAD	9,0	10,0	1450/1200/1000	48/45/42	1100/700/248	36/42,5	9,52	15,88	O	O
AD382MJERAD	11,2	13,0	2000/1700/1400	50/47/44	1500/700/248	44,2/53,5	9,52	15,88	O	O
AD482MJERAD	14,0	16,3	2150/1750/1400	52/48/44	1500/700/248	47,2/56,5	9,52	15,88	O	O
AD542MJERAD	16,0	18,0	2350/1950/1600	54/50/46	1500/700/248	47,2/56,5	9,52	15,88	O	O



KANALNI MODELI (0/300 Pa)	Kapacitet (kW)		Protok zraka (m ³ /h)	Razina buke dB(A)	Neto dimenzija ŠxDxV (mm)	Neto/Bruto težina (kg)	Promjeri cijevi mm (")		Daljinski upravljač (S - standard, O - opcija)	
	Hlađenje	Grijanje					Tekućinski vod (tlačni)	Plinski vod (usisni)	Žičani	Infracrveni
AD722MTERAD	22,6	25,2	4000/3600/3200/2700	67/64/62/60	1333/748/495	88/110	12,7	22,22	O	O
AD962MTERAD	28,0	31,5	4500/4100/3700/3300	68/65/63/61	1333/748/495	88/110	12,7	22,22	O	O

MRV sustavi

unutarnje jedinice



KANALNI MODELI ZA SVJEŽI ZRAK	Kapacitet (kW)		Protok zraka (m³/h)	Razina buke dB(A)	Neto dimenzija ŠxDxV (mm)	Neto/Bruto težina (kg)	Promjeri cijevi mm (")		Daljinski upravljač (S - standard, O - opcija)	
	Hlađenje	Grijanje					Tekućinski vod (tlačni)	Plinski vod (usisni)	Žičani	Infracrveni
AD482MJERAF	14,0	10,0	1900/1600/1460/1200	61/59/57/55	1500/700/248	45,4/52,6	9,52	15,88	O	O
AD722MTERAF	22,6	20,0	2800/2300/1800/1500	61/59/57/55	1333/748/495	88/110	12,7	22,22	O	O
AD962MTERAF	28,0	24,5	3200/2800/2400/2000	62/60/58/55	1333/748/495	88/110	12,7	22,22	O	O



HYDRO BOX	Kapacitet (kW)		Razina zvučnog tlaka db(A) H/M/L	Neto dimenzija ŠxDxV(mm)	Težina (kg)	Temperatura polazne vode (C°)	Povezivanje cijevi - vodeni sklop	
	Hlađenje	Grijanje					Ulaz (inch")	Izlaz (inch")
HU092WVLNA	7,0	9,0	29/32	850/480/310	56	20-50	1	1
HU162WVLNA	14,0	16,0	29/32	850/480/310	56	20-50	1	1
HU312WVLNA	28,0	31,0	29/32	850/480/310	52	20-50	1-1/4	1-1/4



vanjske jedinice

MRV S II	Kapacitet (kW)		Protok zraka (m³/h)	Razina zvučnog tlaka db(A) H/M/L	Neto dimenzija ŠxDxV (mm)	Neto/Bruto težina (kg)	Promjeri cijevi mm (")		Količina radne tvari	Max. visinska razlika IDU & ODU (m)	Max. ukupna duljina cijevi (m)
	Hlađenje nom (min-max)	Grijanje nom (min-max)					Tekućinski vod (tlačni)	Plinski vod (usisni)			
AU042FNERA	12,1	12,1	5400	48/60	950/370/965	90/102	9,52	15,88	3,3	10	120
AU052FNERA	14,0	14,0	5400	60/62	950/370/965	90/102	9,52	15,88	3,3	10	120
Temperaturni raspon: hlađenje od -5°C do +50°C, grijanje od -15°C do +21°C											
AU042FPERA	12,1	12,1	7200	57/57	950/370/1340	115/123	9,52	15,88	4,0	15	300
AU052FPERA	14,0	14,0	7200	58/58	950/370/1340	115/123	9,52	15,88	4,0	15	300
AU062FPERA	15,5	15,5	7200	59/59	950/370/1340	115/123	9,52	15,88	4,0	15	300
AU041FPERA	12,1	12,1	7200	57/57	950/370/1340	115/123	9,52	15,88	4,0	15	300
AU051FPERA	14,0	14,0	7200	58/58	950/370/1340	115/123	9,52	15,88	4,0	15	300
AU061FPERA	15,5	15,5	7200	59/59	950/370/1340	115/123	9,52	15,88	4,0	15	300
Temperaturni raspon: hlađenje od -5°C do +50°C, grijanje od -20°C do +27°C											
AU08NFKERA	22,6	22,6	10000	63/65	1050/400/1636	149/168	9,52	19,05	5,1	15	300
AU10NFKERA	28,0	30,5	10000	64/66	1050/400/1636	149/168	9,52	22,22	5,1	15	300
AU12NFKERA	31,5	31,5	10000	65/67	1050/400/1636	149/168	12,7	25,4	5,1	15	300
Temperaturni raspon: hlađenje od -5°C do +48°C, grijanje od -20°C do +27°C											

MRV 5 Model	Kapacitet (kW)		Protok zraka (m ³ /h)	Razina zvučnog tlaka db(A) H/M/L	Neto dimenzija ŠxDxV (mm)	Neto/Bruto težina (kg)	Promjeri cijevi mm (")		Količina radne tvari	Max. visinska razlika IDU & ODU (m)	Max. ukupna duljina cijevi (m)
	Hlađenje nom (min-max)	Grijanje nom (min-max)					Tekućinski vod (tlačni)	Plinski vod (usisni)			
AV08IMVEVA	25,2	25,2	11000	56	980x750x1690	224/250	9,52	19,05	8,5	110	1000
AV10IMVEVA	28,0	28,0	11000	56	980x750x1690	224/250	9,52	22,22	8,5	110	1000
AV12IMVEVA	33,5	33,5	12000	59	980x750x1690	224/250	12,7	25,4	8,5	110	1000
AV14IMVEVA	40,0	40,0	13500	59	980x750x1690	244/270	12,7	25,4	10	110	1000
AV16IMVEVA	45,0	45,0	13500	60	980x750x1690	244/270	12,7	28,58	10	110	1000
AV18IMVEVA	50,4	50,4	17000	61	1410x750x1690	287/317	15,88	28,58	10	110	1000
AV20IMVEVA	56,0	56,0	17000	61	1410x750x1690	370/400	15,88	28,58	10	110	1000
AV22IMVEVA	61,5	61,5	18000	61	1410x750x1690	370/400	15,88	28,58	10	110	1000
AV24IMVEVA	68,0	68,0	18000	62	1410x750x1690	370/400	15,88	28,58	10	110	1000
AV26IMVEVA	73,5	73,5	19000	62	1410x750x1690	370/400	15,88	28,58	10	110	1000

Temperaturni raspon: hlađenje od -5 °C do +50 °C, grijanje od -23 °C do +21 °C

MRV 5-H											
AV08NMVETA	25,2	25,2	11000	56	980x750x1690	225/280	9,52	19,05	10	110	1000
AV10NMVETA	28,0	28,0	11000	56	980x750x1690	225/280	9,52	22,22	10	110	1000
AV12NMVETA	33,5	33,5	12000	59	980x750x1690	225/280	12,7	25,4	10	110	1000
AV14NMVETA	40,0	40,0	13500	59	980x750x1690	225/280	12,7	25,4	10	110	1000
AV16NMVETA	45,0	45,0	13500	60	980x750x1690	225/280	12,7	28,58	10	110	1000
AV18NMVETA	50,4	50,4	17000	61	1410x750x1690	385/410	15,88	28,58	10	110	1000
AV20NMVETA	56,0	56,0	17000	61	1410x750x1690	385/410	15,88	28,58	10	110	1000
AV22NMVETA	61,5	61,5	18000	61	1410x750x1690	385/410	15,88	28,58	10	110	1000
AV24NMVETA	68,0	68,0	18000	62	1410x750x1690	385/410	15,88	28,58	10	110	1000
AV26NMVETA	73,5	73,5	19000	62	1410x750x1690	385/410	15,88	28,58	10	110	1000

Temperaturni raspon: hlađenje od -5 °C do +52 °C, grijanje od -27 °C do +21 °C

MRV 5-RC											
AV08IMVURA	22,4	22,4	12000	57	980x750x1690	246/271	9,52	19,05	10	110	1000
AV10IMVURA	28,0	28,0	12000	58	980x750x1690	246/271	9,52	22,22	10	110	1000
AV12IMVURA	33,5	33,5	13500	60	980x750x1690	257/282	12,7	25,4	10	110	1000
AV14IMVURA	40,0	40,0	13500	61	980x750x1690	257/282	12,7	25,4	10	110	1000
AV16IMVURA	45,0	45,0	17000	62	1410x750x1690	366/395	12,7	28,58	10	110	1000
AV18IMVURA	50,0	50,0	17000	63	1410x750x1690	366/395	15,88	28,58	10	110	1000
AV20IMVURA	56,0	56,0	19000	63	1410x750x1690	375/404	15,88	28,58	10	110	1000
AV22IMVURA	60,0	60,0	19000	64	1410x750x1690	375/404	15,88	28,58	10	110	1000















Temperaturni raspon: hlađenje od -5 °C do +50 °C, grijanje od -23 °C do +21 °C

MB Frigo Grupa ima preko 40 godina iskustva u području klimatizacije te sa stručnim timom osigurava kvalitetno rješenje u prostorima različitih namjena u cjelokupnom projektu ili u pojedinoj fazi izvedbe projekta.

- konzultacije u pripremi projekata kao i u svim fazama razrade projekta
- pomoć pri odabiru optimalnog rješenja
- stručno savjetovanje pri odabiru opreme
- brza isporuka opreme u traženom roku
- servisa i tehnička podrška pri montaži i puštanju u pogon
- veliki lager rezervnih dijelova
- stručno savjetovanje i tehnička podrška prilikom održavanja montirane opreme



Upravljanje

Upravljanje	Dizajn	Model	Funkcije
Infracrveni daljinski		YR-HQS01	<ul style="list-style-type: none"> * On/Off, odabir načina rada, brzina ventilatora, podešavanje temperature, određivanje smjera ispuha * Turbo način rada, tiši rada * Kontrola lamela za ispuh kod kazetnih jedinica * Prikaz vremena i timer * Podešavanje funkcija za zdravlje * Frost Clean * Pozadinsko svjetlo * Pogodno za upravljanje većinom funkcija putem jednog gumba
		YR-HRS01	<ul style="list-style-type: none"> * On/Off, odabir načina rada, brzina ventilatora, podešavanje temperature, određivanje smjera ispuha * Turbo način rada, tiši rada * Kontrola lamela za ispuh kod kazetnih jedinica * Frost Clean * Timer * Podešavanje funkcija za zdravlje * Pozadinsko svjetlo
Žičani daljinski		HW-SA201ABK	<ul style="list-style-type: none"> * Individualna i grupna kontrola (do 16 unutarnjih jedinica) * On/Off, odabir načina rada, brzina ventilatora, podešavanje temperature, određivanje smjera ispuha * Precizna kontrola odabira temperature $\pm 0.5^{\circ}\text{C}$ * Tjedni timer * Pozadinsko svjetlo * Ugrađeni infracrveni prijemnik signala za kanalne jedinice * Individualna kontrola za kazete * Detekcija nedostatka rashladnog sredstva * Funkcija samočišćenja
		HW-PA201ABK	<ul style="list-style-type: none"> * Display u boji * Individualna i grupna kontrola (do 16 unutarnjih jedinica) * On/off, odabir načina rada, brzina ventilatora, podešavanje temperature, određivanje smjera ispuha * Precizna kontrola odabira temperature $\pm 0.5^{\circ}\text{C}$ ($\pm 1^{\circ}\text{F}$) * Tjedni tajmer * Detektor nedostatka freona * Individualna kontrola za kazete * Multi-jezično sučelje
		HW-BA116ABK	<ul style="list-style-type: none"> * On/Off, odabir načina rada, brzina ventilatora, podešavanje temperature, određivanje smjera ispuha * Individualna i grupna kontrola (do 16 unutarnjih jedinica) * Jednostavan i kompaktan dizajn (86x86x14,80 mm) * Ugrađeni infracrveni prijemnik signala za kanalne jedinice za korištenje infracrvenog daljinskog
		HW-BA101ABT	<ul style="list-style-type: none"> * Individualna i grupna kontrola (do 16 unutarnjih jedinica) * Touch screen * Kaljeno staklo s istaknutim LED zaslonom * On/Off, odabir načina rada, brzina ventilatora, podešavanje temperature, određivanje smjera ispuha * Ugrađeni infracrveni prijemnik signala za kanalne jedinice za korištenje infracrvenog daljinskog
Centralni daljinski		HC-SA164DBT	<ul style="list-style-type: none"> * Individualna, grupna i centralna kontrola (do 64 unutarnje jedinice) * 5-inch TFT LCD touch screen * Tjedni timer * Pohrana podataka o greškama i izvješćivanje * Za komercijalnu seriju potrebni su dodaci PCB adapter i YCJ-A002
		YCZ-A004	<ul style="list-style-type: none"> * Individualna, grupna i centralna kontrola (do 256 unutarnjih jedinica) * 7-inch TFT LCD touch screen * Tjedni timer * Dostupne informacije o unutarnjim jedinicama * Sigurnosna kopija povijesnih podataka * Za komercijalnu seriju potrebni su dodaci PCB adapter i YCJ-A002
		HC-LA1CDBT	<ul style="list-style-type: none"> * 12.5 -inch TFT LCD touch screen * Individualna, grupna i centralna kontrola (do 128 unutarnjih jedinica komercijalne serije) * Tlocrtni prikaz etaža * Web pristup i alarm putem e-maila * Tjedni i dnevni timer * Integrirana opcija za spajanje s drugim uređajima (npr. požarni sustav) * Za komercijalnu seriju potrebni su dodaci PCB adapter i YCJ-A002 * Multi jezična opcija
Prijemnik žičanog daljinskog		RE-02	<ul style="list-style-type: none"> * Infracrveni prijemnik za kanalne jedinice
Modul		YCJ-A002	Modul za spajanje supermatch unutarnjih jedinica na centralni daljinski. Spajanje Wi-Fi modula na uređaj koji nema pripremu za Wi-Fi (kanalne i kazetne). Omogućuje naizmjenično paljenje/gašenje uređaja po radnim satima i greškama.
		WK-B	Omogućuje spajanje zidnih jedinica kućne serije na žičani daljinski upravljač.
		HA-MA1ADB	Omogućuje spajanje MRV sustava na centralni daljinski upravljač HC- LA1CDBT.
		HA-MA164AD	Omogućuje spajanje MRV sustava na centralni daljinski upravljač HC- SA164DBT i YCZ-A004.

Dimenzije unutarnjih jedinica



Expert Nordic / Expert

AS25XCHHRA-NR/AS35XCHHRA-NR
AS25XCAHRA/AS35XCAHRA/AS50XCAHRA

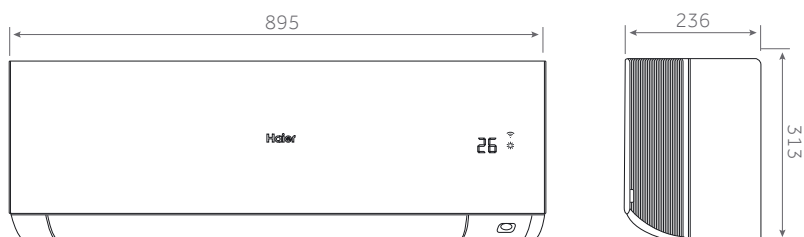

Flexis Plus

AS25S2SF1FA-BH / AS35S2SF1FA-BH
AS25S2SF1FA-S / AS35S2SF1FA-S
AS25S2SF1FA-WH / AS35S2SF1FA-WH



AS50S2SF1FA-BH / AS50S2SF1FA-WH



AS71S2SF1FA-BH / AS71S2SF1FA-WH

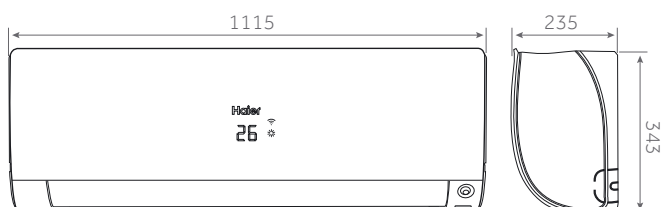

Dimenzije unutarnjih jedinica



Pearl/Pearl Premium

AS25PBAHRA/AS35PBAHRA/AS25PBP
HRA-PRE/AS35PBP HRA-PRE

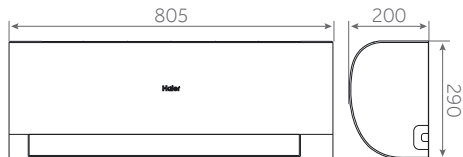

AS50PDAHRA/AS68PDAHRA/AS50PDP
HRA-PRE

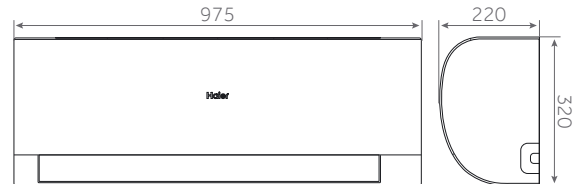

AS71PEPHRA-PRE

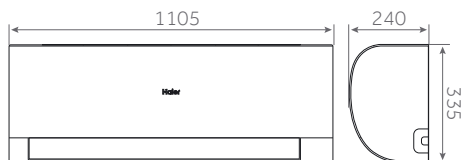

Tundra Plus

AS25TAEHRA-THC/AS35TADHRA-THC



AS50TDDHRA-THC/AS68TDRHRA-THC



Tide Plus

AS25THMHRA-C/AS35TAMHRA-C

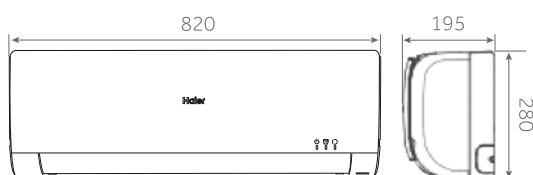

AS50TDMHRA-C /AS68TDRHRA-C

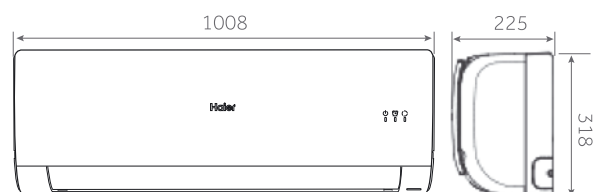

Dimenzije vanjskih jedinica



Expert-Nordic

1U25KEHFRA-NR/1U35KEHFRA-NR

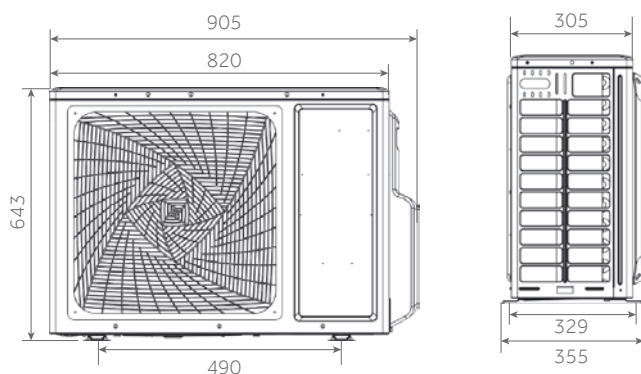

Expert/Flexis Plus

1U25S2SM1FA-2 / 1U35S2SM1FA-2

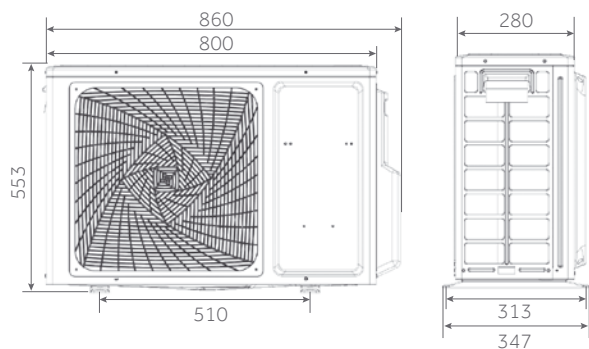

1U50S2SJ2FA-2

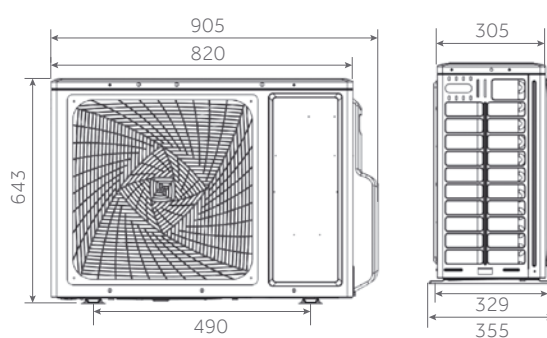

1U71S2ST1FA

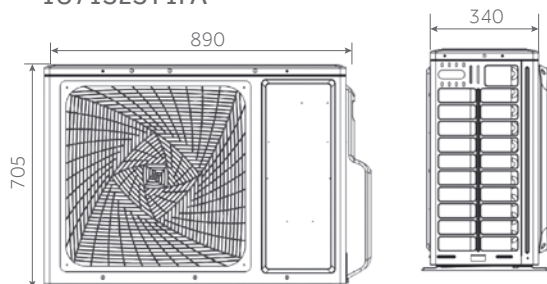

Dimenzije vanjskih jedinica



Pearl - Premium

1U25YEPFRA-PRE

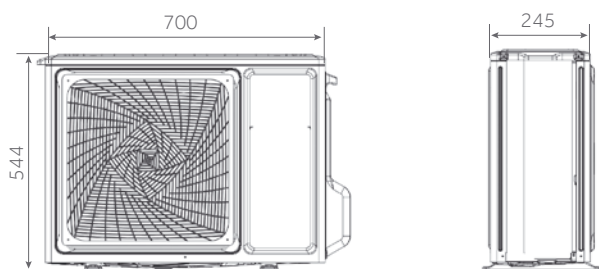

1U35MEPFRA-PRE

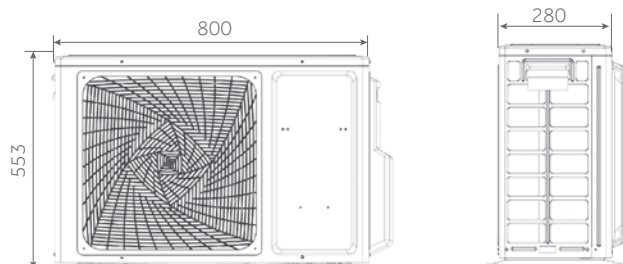

1U50KEPFRA-PRE

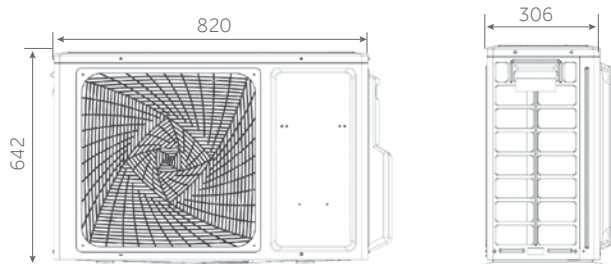

1U71WEPFRA-PRE

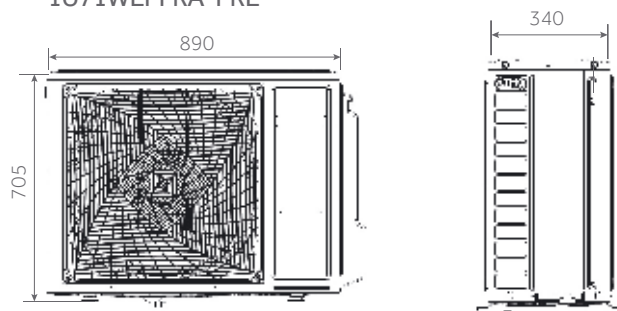

 Pearl

1U68WEGFRA

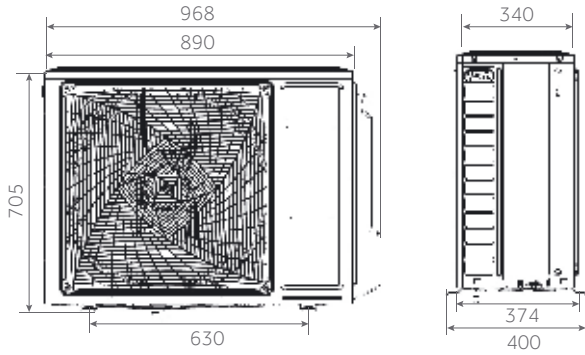

1U25YEGFRA-H1/1U35YEGFRA-H1

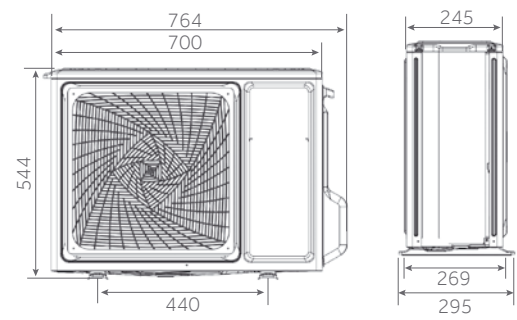

1U50MEGFRA-H

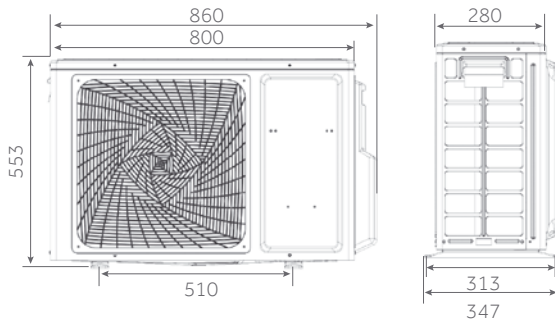

 Tundra Plus

1U25YEFFRA-1

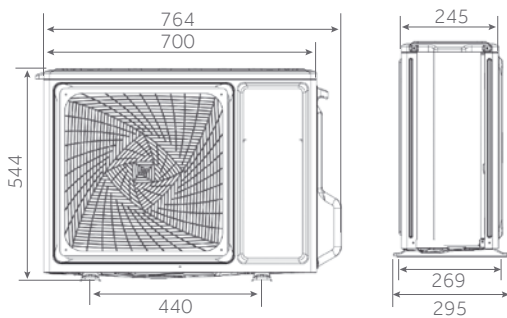

1U35MEEFRA-1/ 1U50MEMFRA-C

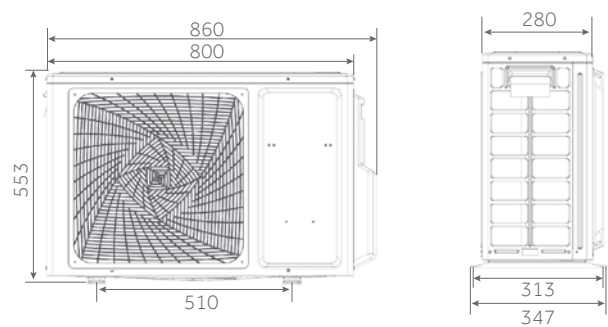

Dimenzije vanjskih jedinica



Tundra Plus / Tide Plus

1U68WEGFRA-C

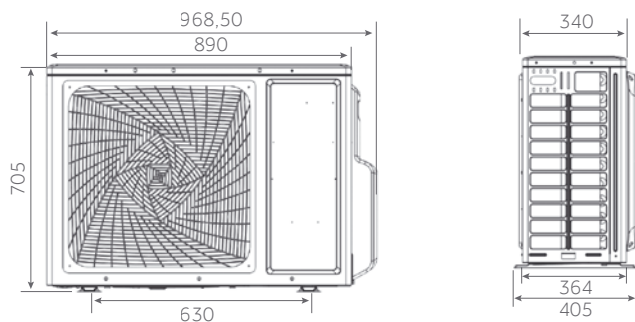

Tide Plus

1U25YEFFRA-C/1U35YEFFRA-C

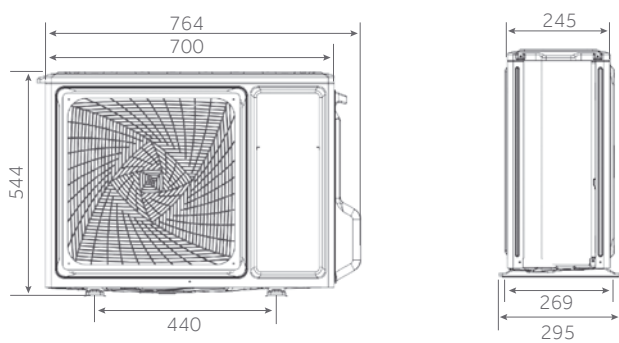

1U50MEMFRA-C

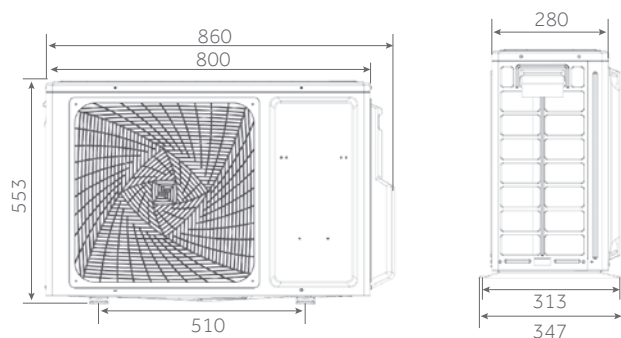

Haier

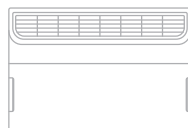
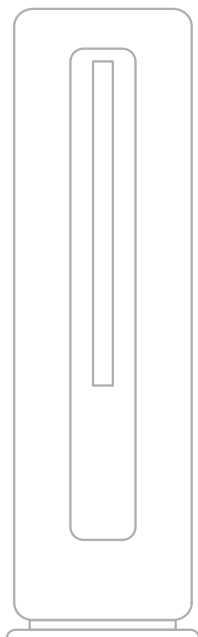
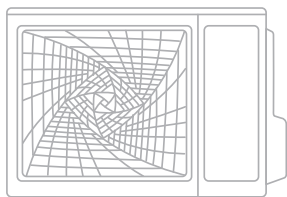

Zagreb

T: +385 (0) 1 66 08 002
trgovina-zg@mbfrigo.hr
Bani 81
10010 Zagreb
Hrvatska

Rijeka

T: +385 (0) 51 683 280
trgovina-ri@mbfrigo.hr
Stupari 28C
51216 Rijeka-Viškovo
Hrvatska

Zadar

T: +385 (0) 23 325 100
trgovina-zd@mbfrigo.hr
Murvica jug 34
23000 Zadar
Hrvatska

Split

T: +385 (0) 21 383 333
trgovina-st@mbfrigo.hr
Put kave 4b
21212 Kaštel Sućurac
Hrvatska

Ne odgovaramo za tiskarske pogreške. Verzija: 03/2025.